

# MINDEO

## ME5800 Barcode Image Engine

### User Manual



Version: ME5800\_UM\_EN\_V1.1.8



# Contents

<b>Contents .....</b>	<b>i</b>
<b>Notes about structure and electric circuit design.....</b>	<b>v</b>
<b>1 Specifications .....</b>	<b>1</b>
1-1 Technical specifications .....	1
1-2 Default setting for each barcode .....	3
<b>2 Getting started.....</b>	<b>5</b>
2-1 Electrical interface/Pin assignment .....	5
2-2 Typical input/output, LDO external, and DC/DC circuitries.....	7
2-3 Power management .....	8
2-4 Installation guide.....	9
2-4-1 Mounting .....	9
2-4-2 Scan window materials.....	10
2-4-3 Scan window positioning .....	11
2-5 Notes of timing.....	13
2-5-1 Timing characteristics.....	13
2-5-2 Timing waveforms .....	13
2-6 Demonstration of engine operation .....	16
2-6-1 Case 1: Beep via RXD/TXD .....	16
2-6-2 Case 2: Beep after pulling down WAKE pin.....	17
2-6-3 Case 3: Request revision via RXD/TXD.....	18
2-6-4 Case 4: Request revision via CTS/RTS .....	19
2-6-5 Case 5: Start decode via RXD/TXD .....	21
2-6-6 Case 6: Start decode after pulling down WAKE pin.....	22
2-6-7 Case 7: Start decode after pulling down CTS pin.....	24
2-6-8 Case 8: Start decode after pulling down TRIG pin.....	25
<b>3 Parameter Menus .....</b>	<b>26</b>
3-1 Introduction.....	26
3-2 Single-parameter setting by scanning 1D barcodes .....	27
3-3 Multiple-parameter setting by scanning a QR code barcode.....	28
3-4 UART interface .....	29
3-5 Scan mode & some global settings.....	32
3-6 Indication .....	37
3-7 Decode illumination mode and Decode aiming pattern .....	38
3-8 Other settings .....	39
3-9 UPC-A.....	42

3-10 UPC-E.....	44
3-11 UPC-E1.....	46
3-12 EAN-13.....	48
3-13 EAN-8.....	50
3-14 Code 39 (Code 32, Trioptic Code 39).....	52
3-15 Interleaved 2 of 5.....	55
3-16 Industrial 2 of 5.....	57
3-17 Matrix 2 of 5.....	58
3-18 Codabar.....	60
3-19 Code 128.....	62
3-20 UCC/EAN 128 (GS1-128).....	64
3-21 ISBT 128.....	66
3-22 Code 93.....	68
3-23 Code 11.....	70
3-24 MSI/Plessey.....	72
3-25 UK/Plessey.....	74
3-26 China Post.....	76
3-27 China Finance.....	77
3-28 GS1 DataBar (GS1 DataBar Truncated).....	79
3-29 GS1 DataBar Limited.....	80
3-30 GS1 DataBar Expanded.....	81
3-31 GS1 Composite.....	82
3-32 PDF417.....	84
3-33 MicroPDF417.....	85
3-34 QR Code.....	86
3-35 Micro QR.....	87
3-36 Data Matrix.....	88
3-37 Han Xin Code.....	89
3-38 Aztec Code.....	90
3-39 G1-G6 & C1-C2 & FN1 substitution string setting.....	91
3-40 G1-G4 string position & Code ID position.....	96
3-41 String transmission.....	97
<b>4 Serial Communication Interface (SCI).....</b>	<b>100</b>
4-1 Communication command of host.....	102
4-1-1 BEEP.....	102
4-1-2 HOST_ACK.....	103
4-1-3 HOST_NAK.....	104
4-1-4 LED_ON.....	105
4-1-5 LED_OFF.....	106
4-1-6 START_DECODE.....	107

4-1-7 STOP_DECODE.....	108
4-1-8 WAKEUP .....	109
4-1-9 PARAM_SEND_HOST .....	110
4-1-10 PARAM_REQUEST.....	112
4-1-11 PARAM_DEFAULTS .....	113
4-1-12 PARAM_WRITE_FLASH.....	114
4-1-13 CUSTOM_DEFAULTS .....	115
4-1-14 REQUEST_REVISION .....	116
4-1-15 PARAMETER_SCANNING .....	117
4-1-16 NO READ .....	118
4-1-17 CAPTURE_IMAGE .....	119
4-1-18 SCAN_ENABLE.....	120
4-1-19 SCAN_DISABLE.....	121
4-1-20 SLEEP .....	122
4-2 Communication command of engine.....	123
4-2-1 ENGINE_ACK.....	123
4-2-2 ENGINE_NAK.....	124
4-2-3 DECODE_DATA.....	125
4-2-4 PARAM_SEND_ENGINE .....	127
4-2-5 REPLY_REVISION.....	128
<b>5 SCI transactions .....</b>	<b>129</b>
5-1 ACK/NAK handshaking .....	129
5-2 Transaction of decode data.....	130
5-3 Transaction examples .....	131
5-4 SCI transaction notes .....	141
<b>6 Enable &amp; Disable “NR” .....</b>	<b>143</b>
<b>7 Enable &amp; Disable configuration by scanning barcode .....</b>	<b>144</b>
<b>8 Glossary.....</b>	<b>145</b>
<b>9 ASCII table .....</b>	<b>146</b>
<b>10 Barcode representing non-printable character .....</b>	<b>147</b>
<b>11 Test barcode symbols.....</b>	<b>148</b>
<b>12 Return default parameters &amp; firmware version.....</b>	<b>151</b>
<b>13 Configuration alphanumeric entry barcode .....</b>	<b>152</b>



## Notes about structure and electric circuit design

- 1) Read [2-1 Electrical interface/Pin assignment](#) carefully to learn about the electrical interface design. Pin WAKE can be connected to the host if the operation of awaking the engine from Sleep mode is in need.
- 2) The engine must be electrically isolated. In a radio system if antennas are located closely to the engine, the performance reduction of engine can exist.
- 3) Leave sufficient space to accommodate the maximum size of the engine.



When selecting any trigger mode, the ambient temperature should not exceed the maximum operating temperature of the engine. If the temperature exceeds the maximum operating temperature, the performance of the engine may be reduced, the life of the product may be shortened, and permanent damage may occur to the engine.





# 1 Specifications

## 1-1 Technical specifications

<b>Dimensions</b>	H × W × D : 15.5 mm × 21.6 mm × 12.0 mm		
<b>Weight</b>	7.0 g		
<b>Indicator Interface</b>	To control external Beeper and LED		
<b>Interface Supported</b>	TTL-232		
<b>Trigger Mode</b>	Command, Level		
<b>Cable</b>	Tapered 12-pin flex strip (12 × 0.5 mm)		
<b>Programming Method</b>	Scanning special barcodes in sequence, or sending commands via TTL-232 interface		
<b>Firmware Upgrade</b>	Online		
<b>Input Voltage</b>	3.3 ± 5% VDC		
<b>Current</b>	4 mA (sleeping), 100 mA (standby), 410 mA (scanning)		
<b>Illumination LED</b>	White emitting color, standard: 2700K, optional: 5000K		
<b>Aiming</b>	525 nm peak wavelength, green LED		
<b>Image Size</b>	1280 × 800 pixels		
<b>Field of View</b>	Horizontal: 42°, vertical: 26.5°		
<b>Scanning Angle</b>	±70°, ±72°, 360° (Skew, Pitch, Roll)		
<b>Print Contrast</b>	20% minimum reflectance difference		
<b>Decoding Capability</b>	1D: UPC-A, UPC-E, UPC-E1, EAN-13, EAN-8, ISBN (Bookland EAN), ISSN, Code 39, Code 39 full ASCII, Code 32, Trioptic Code 39, Interleaved 2 of 5, Industrial 2 of 5, Matrix 2 of 5, Codabar (NW7), Code 128, ISBT 128, Code 93, Code 11 (USD-8), MSI/Plessey, UK/Plessey, UCC/EAN 128 (GS1-128), China Post, China Finance, GS1 DataBar (formerly RSS) variants		
	2D: PDF417, MicroPDF417, QR Code, Micro QR Code, DataMatrix, Han Xin Code, Aztec Code, GS1 Composite		
<b>Minimum Resolution</b>	HD: 1D (Code 39): 3 mil, 2D (QR): 5 mil SR: 1D (Code 39): 4 mil, 2D (PDF417): 6.7 mil		
<b>Decoding Depth</b>		<b>High Density Series (HD)</b>	<b>Standard Range Series (SR)</b>
	3 mil Code 39 (3 chars)	60 – 90 mm	/
	4 mil Code 128 (9 chars)	45 – 135 mm	85 – 145 mm
	10 mil Code 39 (3 chars)	20 – 260 mm	30 – 310 mm
	13 mil UPC (6 chars)	17 – 275 mm	25 – 330 mm
	20 mil Code 39 (1 char)	38 – 410 mm	30 – 485 mm
	5 mil QR (40 chars)	55 – 95 mm	/
	6.7 mil PDF417 (20 chars)	35 – 175 mm	75 – 190 mm
	10 mil QR (20 chars)	20 – 195 mm	48 – 190 mm
	10 mil DM (20 chars)	25 – 185 mm	50 – 185 mm
20 mil QR (20 chars)	20 – 320 mm	20 – 390 mm	
<b>Temperature</b>	Operating: -20 °C to 55 °C (-4 °F to 131 °F) Storage: -40 °C to 70 °C (-40 °F to 158 °F)		

<b>Humidity</b>	5% to 95% (non-condensing)						
<b>Mechanical Vibration</b>	<p>IEC60068-2-6</p> <p>Un-powered engine withstands a random vibration along each of the X, Y and Z axes for a period of one hour per axis, define as follows:</p> <table> <tr> <td>20 to 80 Hz</td> <td>Ramp up to 0.04 G<sup>2</sup>/Hz at the rate of 3 dB/oct</td> </tr> <tr> <td>80 to 350 Hz</td> <td>0.04 G<sup>2</sup>/Hz</td> </tr> <tr> <td>350 Hz to 2000 Hz</td> <td>Ramp down at the rate of 3 dB/oct</td> </tr> </table>	20 to 80 Hz	Ramp up to 0.04 G <sup>2</sup> /Hz at the rate of 3 dB/oct	80 to 350 Hz	0.04 G <sup>2</sup> /Hz	350 Hz to 2000 Hz	Ramp down at the rate of 3 dB/oct
20 to 80 Hz	Ramp up to 0.04 G <sup>2</sup> /Hz at the rate of 3 dB/oct						
80 to 350 Hz	0.04 G <sup>2</sup> /Hz						
350 Hz to 2000 Hz	Ramp down at the rate of 3 dB/oct						
<b>Mechanical Shock</b>	<p>IEC60068-2-27</p> <p>Shock pulse: 0.5 ms, Maximal acceleration: 1500 G, Shock direction &amp; time: ±X-axis, ±Y-axis, ±Z-axis, 3 times for each direction, total of 18 times.</p>						
<b>Safety</b>	<p>EMC: EN55022, EN55024</p> <p>Electrical Safety: EN60950-1</p> <p>Photobiological Safety: EN62471:2008</p> <p>RF Immunity: IEC61000-4-3, 10 V/m</p> <p>Artificial Light Immunity: 100,000 Lux</p>						

## 1-2 Default setting for each barcode

Code type	Read enable	Check digit verification	Check digit transmission	Min. code length	Proprietary code ID	AIM code ID
UPC-A	√	√	√	(12) <sup>2</sup>	A	]Em
UPC-E	√	√	√	(8) <sup>2</sup>	D	]Em
UPC-E1	-	√	√	(8) <sup>2</sup>	D	]X0
EAN-13	√	√	√	(13) <sup>2</sup>	A	]Em
EAN-8	√	√	√	(8) <sup>2</sup>	C	]E4
ISBN (Bookland EAN)/ISSN <sup>1</sup>	√	√	√	(13) <sup>2</sup>	B	]Em
Code 39	√	-	-	1	M	]Am
Interleaved 2 of 5	√	-	-	6	I	]Im
Industrial 2 of 5	-	-	-	4	H	]S0
Matrix 2 of 5	√	-	-	6	X	]X0
Codabar	√	-	-	4	N	]Fm
Code 128	√	√	-	1	K	]Cm
UCC/EAN 128 (GS1-128)	√	√	-	1	K	]Cm
ISBT 128	√	√	-	1	K	]Cm
Code 93	√	√	-	1	L	]Gm
Code 11	-	√	-	4	V	]H3
MSI/Plessey	-	-	-	4	O	]Mm
UK/Plessey	-	√	-	1	U	]Mm
China Post	√	-	-	(11) <sup>2</sup>	T	]Im
China Finance	√	-	-	(10) <sup>2</sup>	Y	-
GS1 DataBar	√	-	-	(16) <sup>2</sup>	R	]em
GS1 DataBar Truncated <sup>3</sup>	√	-	-	(16) <sup>2</sup>	R	]em
GS1 DataBar Limited	√	-	-	(16) <sup>2</sup>	R	]em
GS1 DataBar Expanded	√	-	-	1	R	]em
GS1 Composite	-	-	-	-	y	]em
PDF417	√	-	-	-	p	]Lm

Code type	Read enable	Check digit verification	Check digit transmission	Min. code length	Proprietary code ID	AIM code ID
MicroPDF417	-	-	-	-	p	]Lm
DataMatrix	√	-	-	-	d	]dm
QR code	√	-	-	-	q	]Qm
Han Xin Code	-	-	-	-	h	]X0
Aztec Code	-	-	-	-	a	]zm

Note: <sup>1</sup>The settings for ISBN/ISSN and EAN-13 must be the same except the code ID.

<sup>2</sup>Fixed-length symbols.

<sup>3</sup>The settings for GS1 DataBar Truncated and GS1 DataBar must be the same.

## 2 Getting started

### 2-1 Electrical interface/Pin assignment

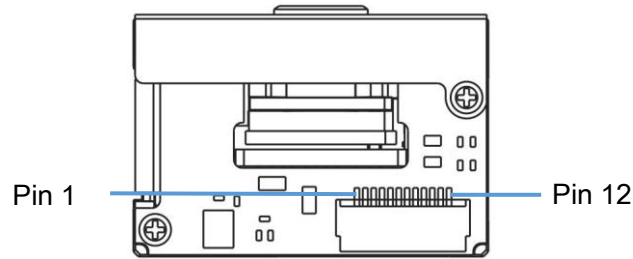

Pin No.	Signal Name	Type	Description
1	Flash_DWLD*	Input	Flash download. Pull it low and then power on, the engine will enter upgrade-ready mode. Pull it high or leave it unconnected, then power on, the engine will enter normal work mode.
2	VCC	Power	Power supply: 3.15 to 3.45 VDC.
3	GND	Power	Power/Signal Ground: 0V reference.
4	RXD	Input	Received data: Serial data receive input port.
5	TXD	Output	Transmitted data: Serial data transmit port.
6	CTS*	Input	Clear-to-send: serial port handshaking line (input).
7	RTS*	Output	Request-to-send: serial port handshaking line (output).
8	PWRDWN	Output	Power down ready: When high, the engine is in Sleep mode.
9	BPR*	Output	Beeper: Low current beeper output.
10	DLED*	Output	Decode LED: Low current decode LED output.
11	WAKE*	Input	Wake up: When the engine is in Sleep mode, the falling edge of this pin awakens the engine.
12	TRIG*	Input	Trigger: Hardware triggering line, driving this pin low causes the engine to start an image capture and decode session.

Note: \*=logic low. Signal names with the "\*" modifier are asserted when at the ground level. Signals names without the "\*" modifier are asserted when at the positive supply voltage level.

The engine has a TTL-232 interface to communicate with a host. The following diagram demonstrates the connection.

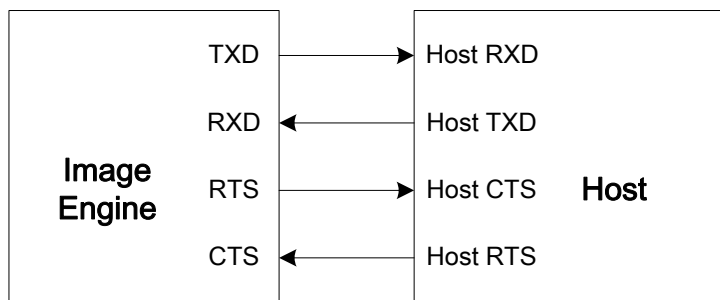

RTS and CTS are only used for hardware flow control and should be leaved unconnected or tied to  $V_{CC}$  by 100K Ohm resistors when they are not used.

## 2-2 Typical input/output, LDO external, and DC/DC circuitries

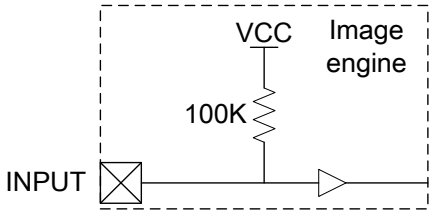
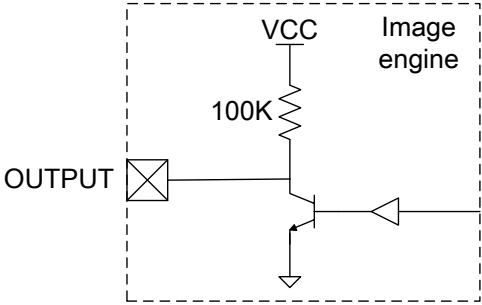
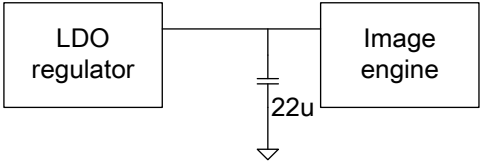
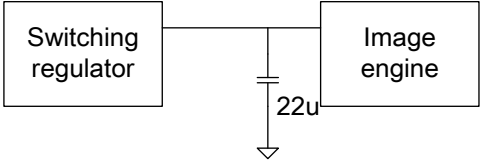
<p>Input: each input I/O pin is internally pulled up by a 100K Ohm resistor.  <math>V_{CC} = 3.3\text{ V}</math>.</p> <table border="1" data-bbox="252 389 687 555"> <thead> <tr> <th></th> <th>Min.</th> <th>Max.</th> </tr> </thead> <tbody> <tr> <td><math>V_{inL}</math></td> <td>-0.3V</td> <td>0.7V</td> </tr> <tr> <td><math>V_{inH}</math></td> <td>2.4V</td> <td>3.6V</td> </tr> </tbody> </table>		Min.	Max.	$V_{inL}$	-0.3V	0.7V	$V_{inH}$	2.4V	3.6V	
	Min.	Max.								
$V_{inL}$	-0.3V	0.7V								
$V_{inH}$	2.4V	3.6V								
<p>Output: each output port is an open-drain pad with a 100K Ohm pull-up resistor and the maximum sink current is 100 mA.</p>										
<p>External LDO circuitry: it is recommended to apply low noise LDO (Low Dropout Voltage) regulators.</p>										
<p>External switching regulator circuitry:</p> <table border="1" data-bbox="213 1330 730 1496"> <thead> <tr> <th></th> <th>Min.</th> <th>Max.</th> </tr> </thead> <tbody> <tr> <td>Switching Frequency</td> <td>1 MHz</td> <td>-</td> </tr> <tr> <td>Ripple <math>V_{P-P}</math></td> <td>-</td> <td>50 mV</td> </tr> </tbody> </table>		Min.	Max.	Switching Frequency	1 MHz	-	Ripple $V_{P-P}$	-	50 mV	
	Min.	Max.								
Switching Frequency	1 MHz	-								
Ripple $V_{P-P}$	-	50 mV								

## 2-3 Power management

The scan engine has two power states (Awake and Sleep) and two power modes (Continuous and Low).

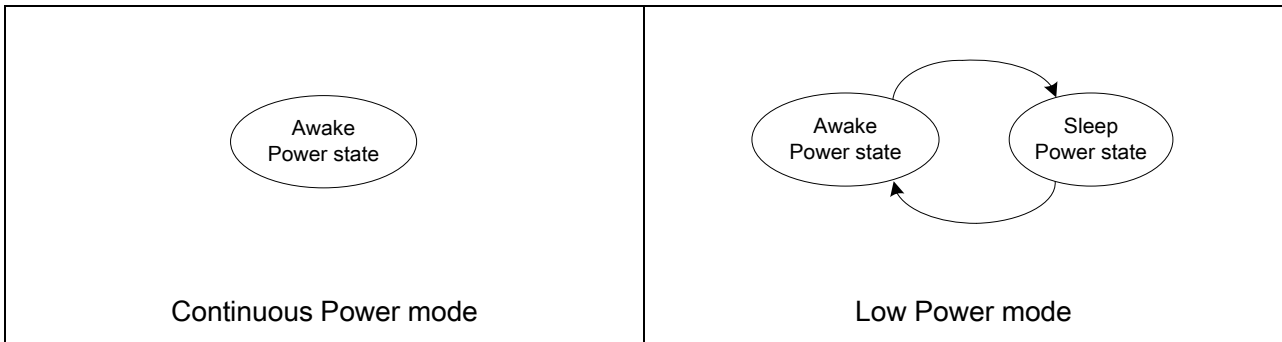

Once the engine is awakened, at least 1 second must elapse before it re-enters Sleep Power state. Two methods of waking-up the engine are listed in Table 2-1.

**Table 2-1 Waking-up the engine**

Signal	State to Wake-up
WAKE*	Falling edge.
TRIG*	Falling edge.
CTS*	Falling edge.
RXD	Send WAKEUP (0x00) command.
Signal names with the "*" modifier are asserted when at the ground level.	
Signals names without the "*" modifier are asserted when at the positive supply voltage level.	

### Power states

The engine has two power states: Awake Power state and Sleep Power state.

When the engine is in Low Power mode, the engine will automatically switch to the Sleep Power state whenever possible.

When the engine is in the Sleep Power state, the PWRDWN signal is asserted. The engine must be awakened from the Sleep Power state before performing any functions. The switch between two states only can be made by command, refer to [Sleep mode](#) of [3-5 Scan mode & some global settings](#).

### Power modes

The scan engine has two power modes: Continuous Power mode and Low Power mode.

In Continuous Power mode, the scan engine remains in the Awake Power state after each decode-tempt unless it receives a SLEEP command.

In Low Power mode, the scan engine enters into a low-power-consumption Sleep Power state whenever possible. This makes the Low Power mode more suitable for battery powered applications. The engine must be awakened from the Sleep Power state before performing any functions.



## 2-4 Installation guide

### 2-4-1 Mounting

Units = mm

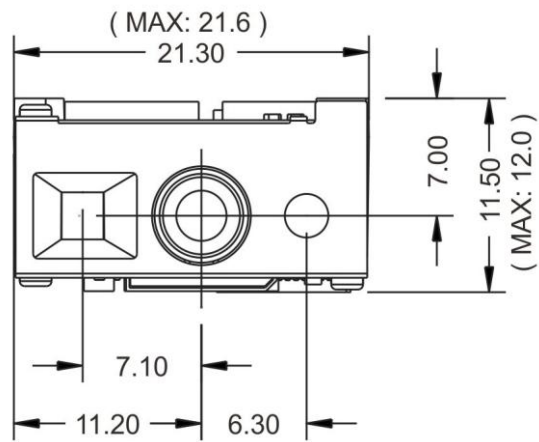
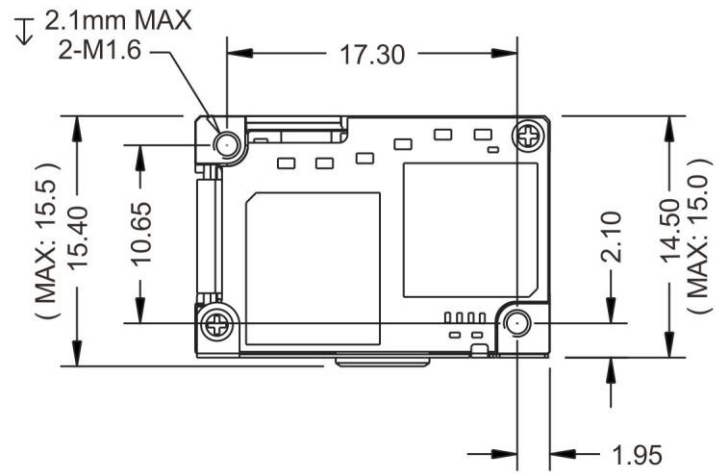

## 2-4-2 Scan window materials

Many window materials that look perfectly clear to eyes can contain stresses and distortions which affect the optics module and reduce engine performance. Following are the description of three popular scan window materials:

- 1) Poly-methyl Methacrylic (PMMA): Also known as Cell Cast Acrylic, and is relatively soft.
- 2) Allyl Diglycol Carbonate (ADC): Also known as CR-39.
- 3) Chemically tempered float glass.

Among these three materials, the chemically tempered float glass is a hard material which provides the most excellent scratch and abrasion resistance.

Note: The structure design must be well considered to pass drop test.

### 2-4-3 Scan window positioning

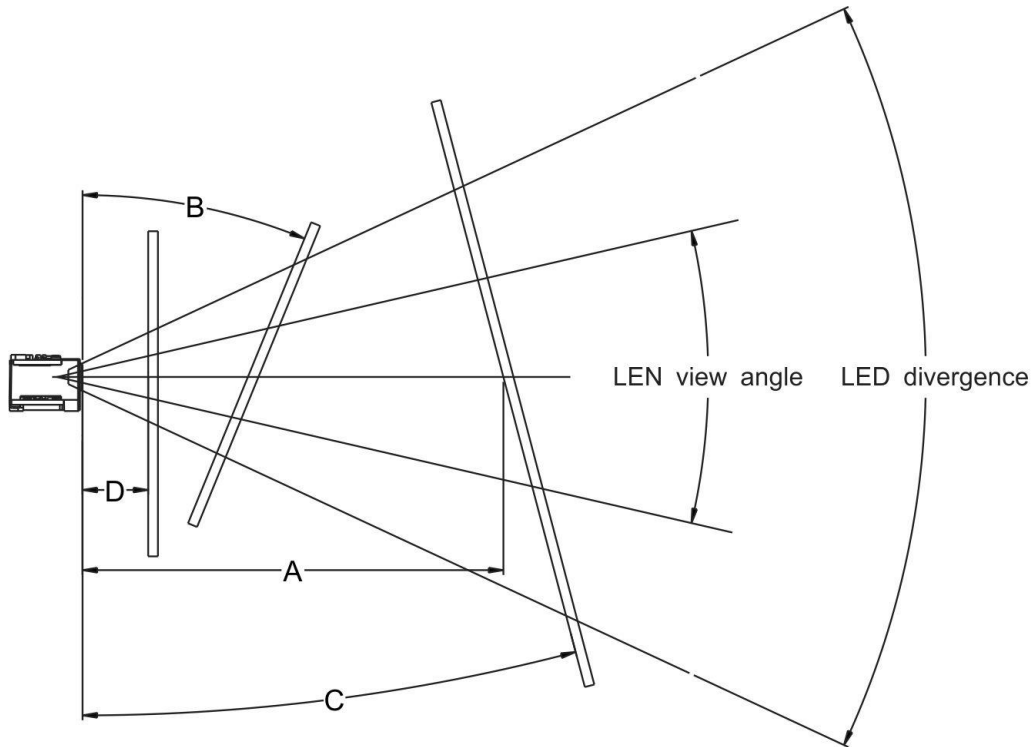

A	Scan Window Distance from Engine (mm)	0 mm	0.5 mm	1 mm	2 mm	3 mm	4 mm
B	Max. Positive Angle	0°	0°	25°	25°	26°	26°
C	Min. Negative Angle	0°	0°	25°	25°	26°	26°
D	Placing the scan window vertically is feasible?	Yes		No			

A	Scan Window Distance from Engine (mm)	5 mm	6 mm	7 mm	8 mm	9 mm	10 mm
B	Max. Positive Angle	27°	27°	27°	27°	28°	28°
C	Min. Negative Angle	27°	27°	27°	27°	28°	28°
D	Placing the scan window vertically is feasible?	No					

A	Scan Window Distance from Engine (mm)	11 mm	12 mm	13 mm	14 mm	15 mm	16 mm
B	Max. Positive Angle	27°	27°	26°	26°	26°	25°
C	Min. Negative Angle	27°	27°	26°	26°	26°	25°
D	Placing the scan window vertically is feasible?	No					

A	Scan Window Distance from Engine (mm)	17 mm	18 mm	19 mm	20 mm
B	Max. Positive Angle	24°	24°	23°	22°
C	Min. Negative Angle	24°	24°	23°	22°
D	Placing the scan window vertically is feasible?	No			

Note:

- 1) The thickness of the scan window is 2 mm.
- 2) The scan window should be high transparent & non-colored glass.
- 3) If the thickness of the scan window is less than 2 mm, then different thickness of the scan window will not affect the performance of the engine.

## 2-5 Notes of timing

### 2-5-1 Timing characteristics

Table 2-2 Timing characteristics

Symbol	Parameter	Conditions	Min.	Typ.	Max.	Unit
<b>General characteristics</b>						
$t_f$	High to low fall time	$C_L=50\text{pf}$			1.0	us
$t_r$	Low to high rise time	$C_L=50\text{pf}$			1.0	us
<b>Trigger timing</b>						
$t_{\text{trig\_l}}$	Trigger low level hold time		20			ms
$t_{\text{trig\_h}}$	Trigger high level hold time		20			ms
$t_{\text{dbt}}$	Trigger de-bounce time				1.1	ms
<b>Wake up timing</b>						
$t_{\text{slp2fo}}$	Sleep to full operation			25		ms

### 2-5-2 Timing waveforms

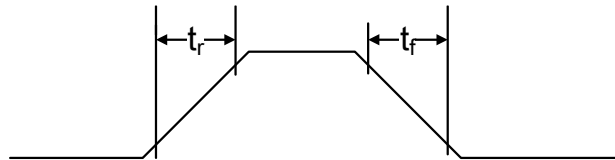

Figure 2-1 General characteristics

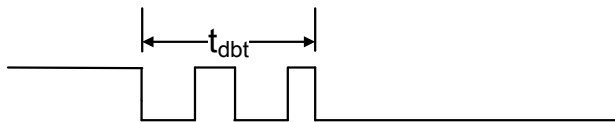

Figure 2-2 Trigger de-bounce timing

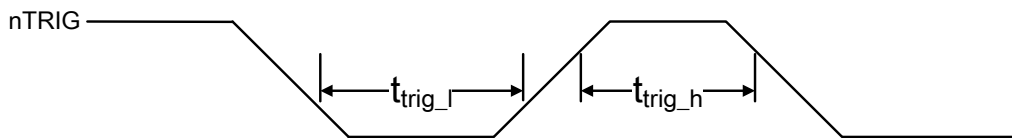
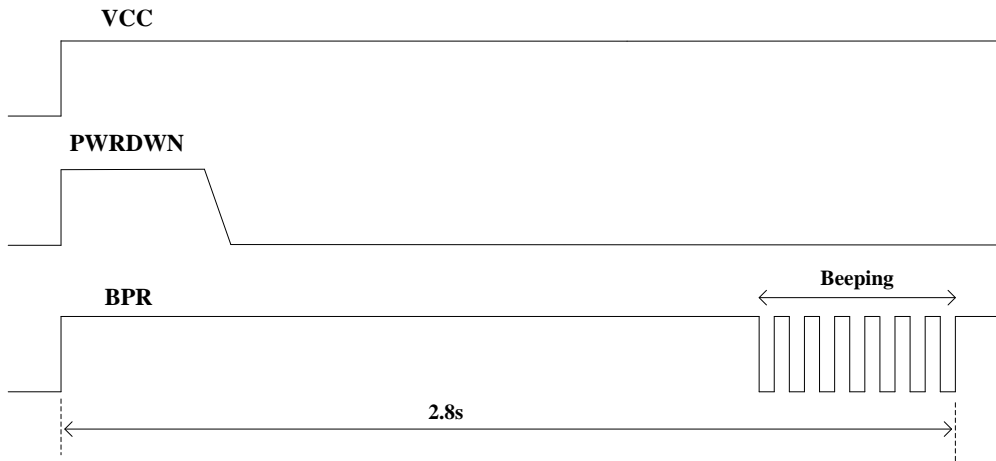
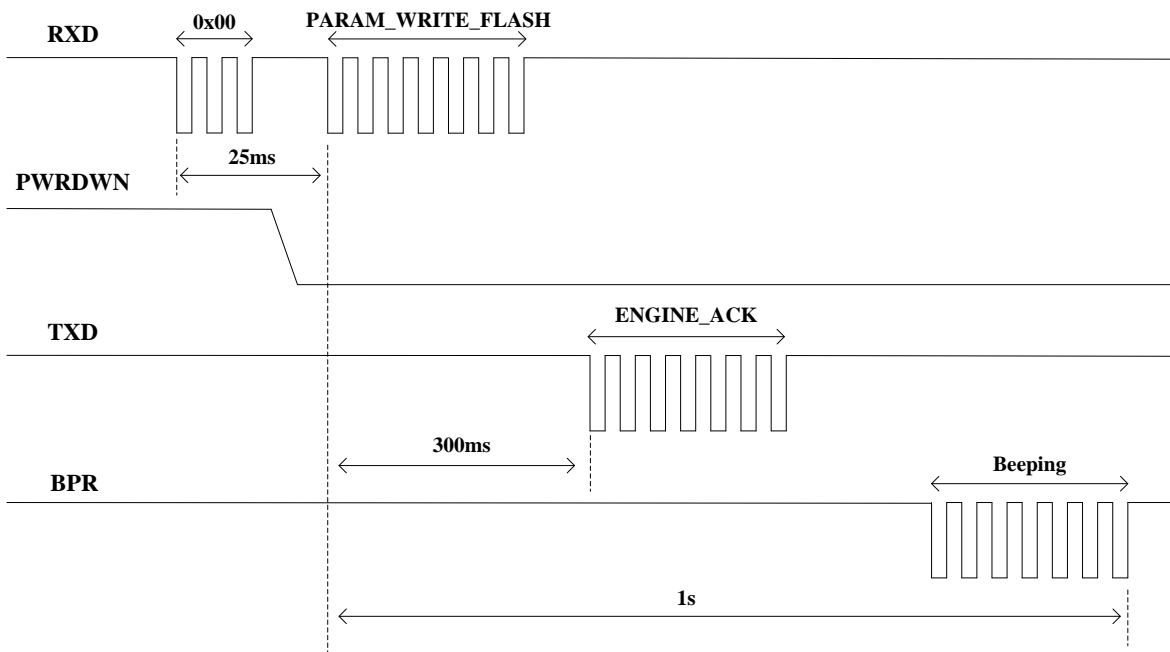

Figure 2-3 Hardware trigger timing



Note: Don't operate the engine within this 2.8 s.

Figure 2-4 Power on timing



Note: Don't operate the engine within this 1 s.

Figure 2-5 PARAM\_WRITE\_FLASH timing

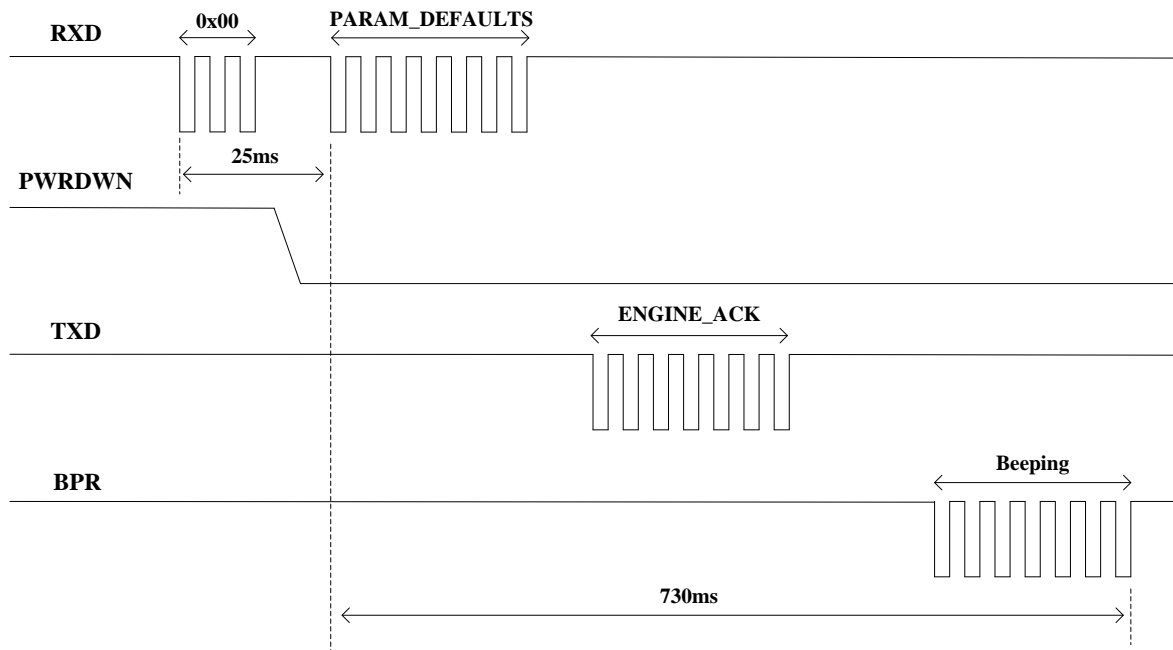

Note: Don't operate the engine within this 730 ms.

Figure 2-6 PARAM\_DEFAULTS timing

## 2-6 Demonstration of engine operation

The following cases demonstrate how to operate an engine quickly and easily.

### 2-6-1 Case 1: Beep via RXD/TXD

Assuming that the engine is in Sleep Power state, host sends WAKEUP command to awaken the engine and then sends a BEEP command.

- ① Host sends WAKEUP command (0x00).
- ② After more than 25 ms, host sends a BEEP command (0x05 0xE6 0x04 0x00 0x00 0xFF 0x11).
- ③ After receiving the command, the engine returns an ENGINE\_ACK command (0x00 0x05 0xD0 0x00 0x00 0xFF 0xFF 0xFF 0x2B).
- ④ The engine outputs signals to drive an external beeper.

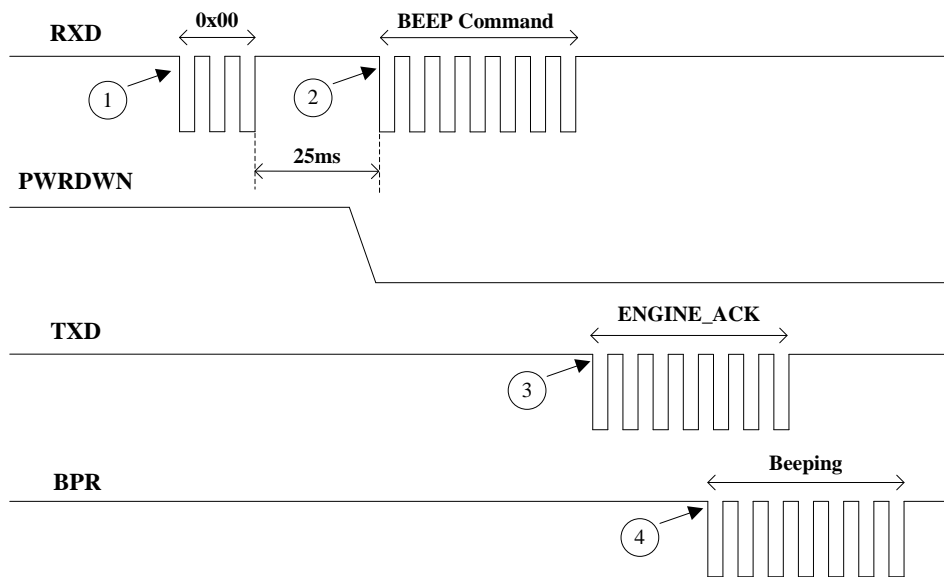

Assuming that the engine is in Awake Power state, host sends a BEEP command.

- ① Host sends a BEEP command (0x05 0xE6 0x04 0x00 0x00 0xFF 0x11).
- ② After receiving the command, the engine returns an ENGINE\_ACK command (0x00 0x05 0xD0 0x00 0x00 0xFF 0xFF 0xFF 0x2B).
- ③ The engine outputs signals to drive an external beeper.

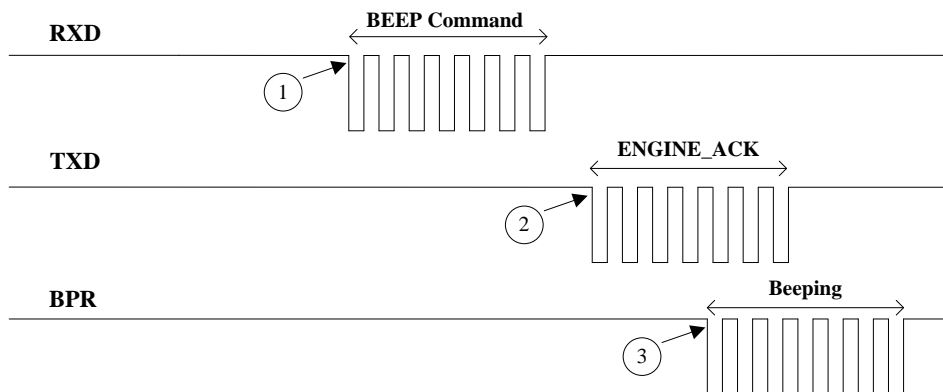



## 2-6-2 Case 2: Beep after pulling down WAKE pin

Assuming that the engine is in Sleep Power state, host pulls down the WAKE pin to awaken the engine and then sends a BEEP command.

- ① Host pulls down the WAKE pin.
- ② After more than 25 ms, host sends a BEEP command (0x05 0xE6 0x04 0x00 0x00 0xFF 0x11).
- ③ After receiving the command, the engine returns an ENGINE\_ACK command (0x00 0x05 0xD0 0x00 0x00 0xFF 0xFF 0xFF 0x2B).
- ④ The engine outputs signals to drive an external beeper.

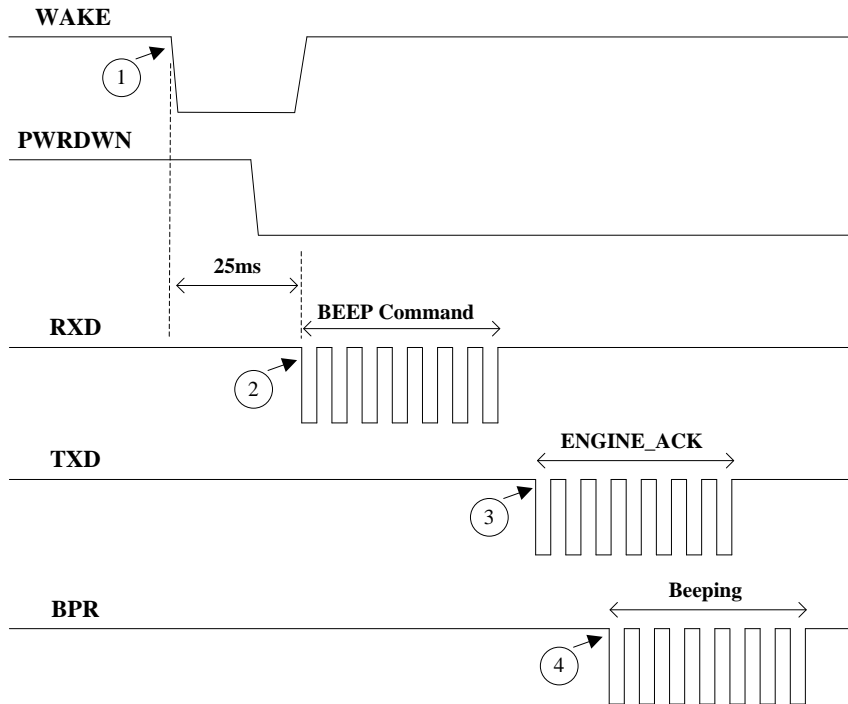

Assuming that the engine is in Awake Power state, host sends a BEEP command.

- ① Host sends a BEEP command (0x05 0xE6 0x04 0x00 0x00 0xFF 0x11).
- ② After receiving the command, the engine returns an ENGINE\_ACK command (0x00 0x05 0xD0 0x00 0x00 0xFF 0xFF 0xFF 0x2B).
- ③ The engine outputs signals to drive an external beeper.

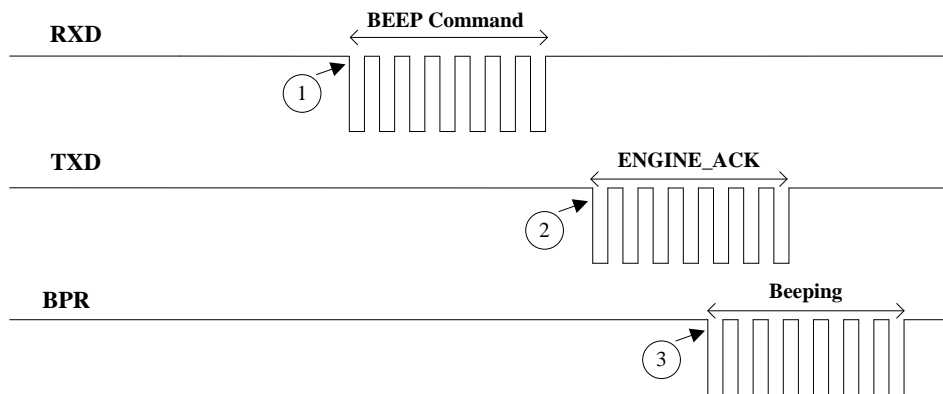

### 2-6-3 Case 3: Request revision via RXD/TXD

Assuming that the engine is in Sleep Power state, host sends WAKEUP command to awaken the engine and then ask for software version information.

- ① Host sends WAKEUP command (0x00).
- ② After more than 25 ms, host sends a REQUEST\_REVISION command (0x04 0xA3 0x04 0x00 0xFF 0x55).
- ③ After receiving the command, the engine returns REPLY\_REVISION packet which contains firmware version information.

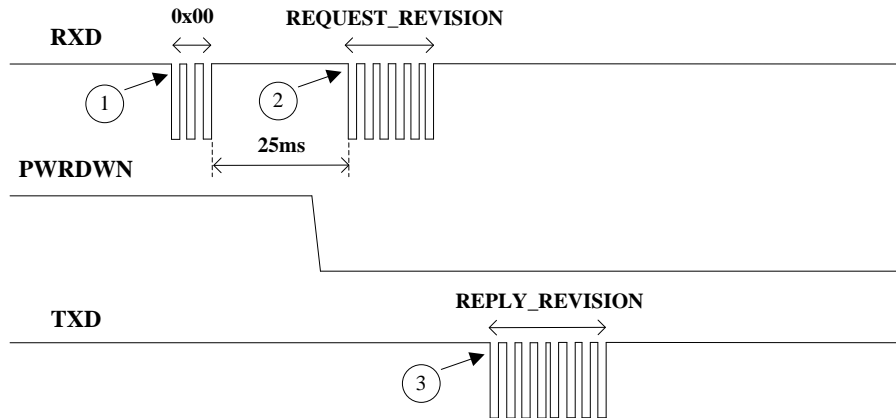

Assuming that the engine is in Awake Power state, host asks for software version information.

- ① Host sends a REQUEST\_REVISION command (0x04 0xA3 0x04 0x00 0xFF 0x55).
- ② After receiving the command, the engine returns REPLY\_REVISION packet which contains firmware version information.

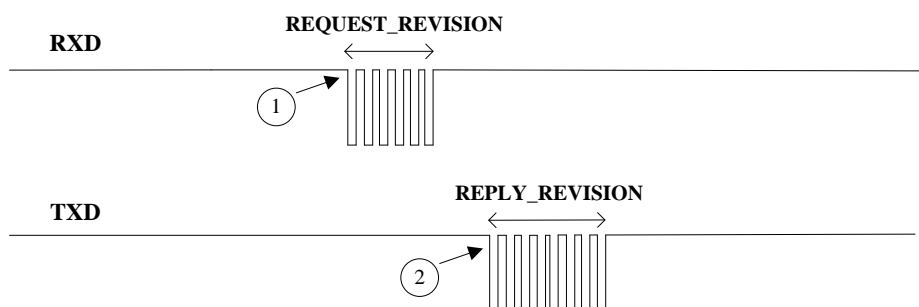

#### 2-6-4 Case 4: Request revision via CTS/RTS

Assuming that the engine is in Sleep Power state, host pulls down the CTS pin to awaken the engine and then ask for software version information.

- ① Host pulls down the CTS pin.
- ② After more than 25 ms, the engine pulls down the PWRDWN pin.
- ③ The engine pulls down the RTS pin.
- ④ Host sends a REQUEST\_REVISION command (0x04 0xA3 0x04 0x00 0xFF 0x55).
- ⑤ Host pulls up the CTS pin.
- ⑥ The engine pulls up the RTS pin.
- ⑦ After receiving the command, the engine returns REPLY\_REVISION packet which contains firmware version information.

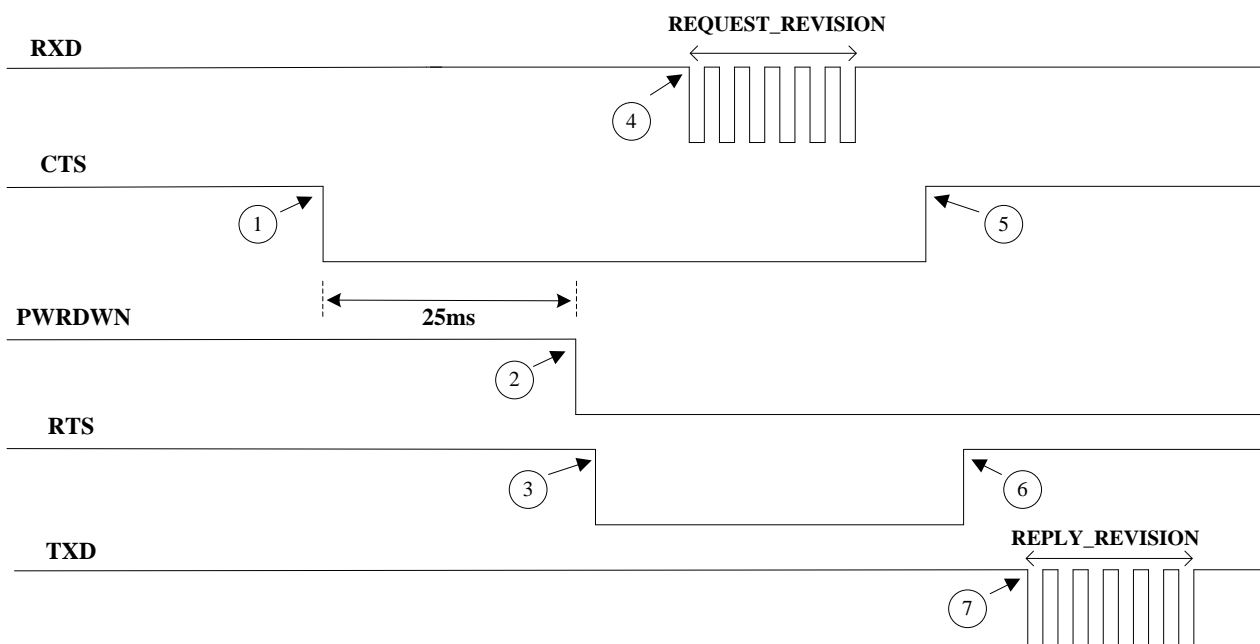

Assuming that the engine is in Awake Power state, host asks for software version information.

- ① Host pulls down the CTS pin.
- ② The engine pulls down the RTS pin.
- ③ Host sends a REQUEST\_REVISION command (0x04 0xA3 0x04 0x00 0xFF 0x55).
- ④ Host pulls up the CTS pin.
- ⑤ The engine pulls up the RTS pin.
- ⑥ After receiving the command, the engine returns REPLY\_REVISION packet which contains firmware version information.

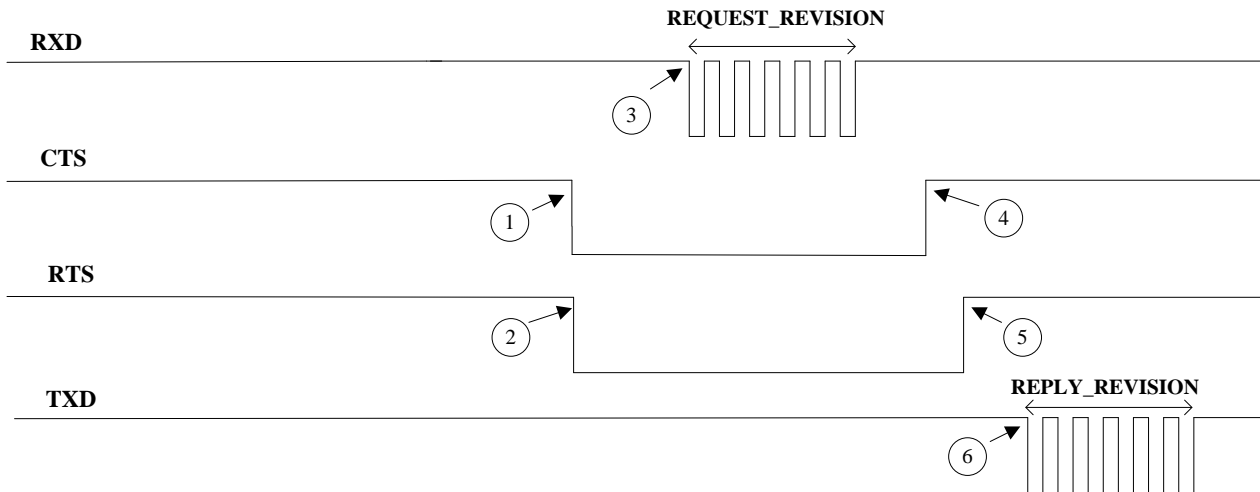

### 2-6-5 Case 5: Start decode via RXD/TXD

Assuming that the engine is in Sleep Power state, host sends WAKEUP command to awaken engine and then sends a STRAT\_DECODE command.

- ① Host sends WAKEUP command (0x00).
- ② After more than 25 ms, host sends a Host (Trigger mode) command (0x09 0xD6 0x04 0x00 0x00 0x01 0x91 0x01 0x05 0xFE 0x85) to switch the trigger mode to be Host mode. If engine currently operates in Host mode, this step can be ignored.
- ③ After receiving the command, the engine returns an ACK command (0x00 0x05 0xD0 0x00 0x00 0xFF 0xFF 0xFF 0x2B).
- ④ Host sends a STRAT\_DECODE command (0x04 0xE4 0x04 0x00 0xFF 0x14).
- ⑤ After receiving the command, the engine returns an ACK command and then starts to decode.

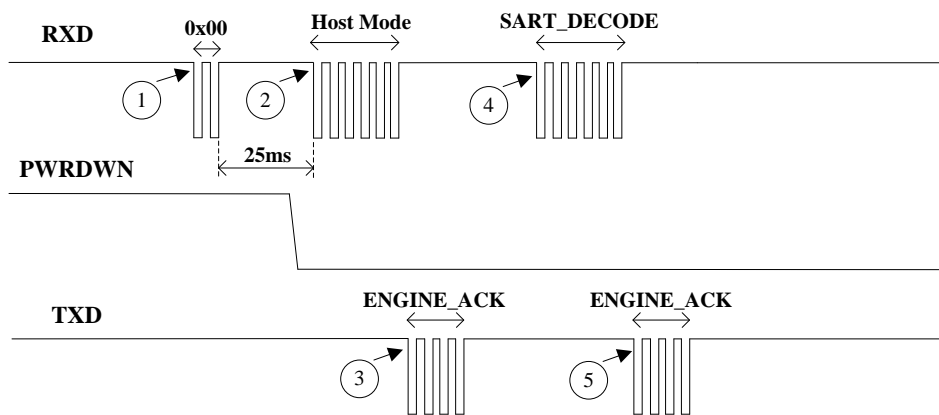

Assuming that the engine is in Awake Power state, host sends a STRAT\_DECODE command.

- ① Host sends a Host (Trigger mode) command (0x09 0xD6 0x04 0x00 0x00 0x01 0x91 0x01 0x05 0xFE 0x85) to switch the trigger mode to be Host mode. If engine currently operates in Host mode, this step can be ignored.
- ② After receiving the command, the engine returns an ACK command (0x00 0x05 0xD0 0x00 0x00 0xFF 0xFF 0xFF 0x2B).
- ③ Host sends a STRAT\_DECODE command (0x04 0xE4 0x04 0x00 0xFF 0x14).
- ④ After receiving the command, the engine returns an ACK command and then starts to decode.

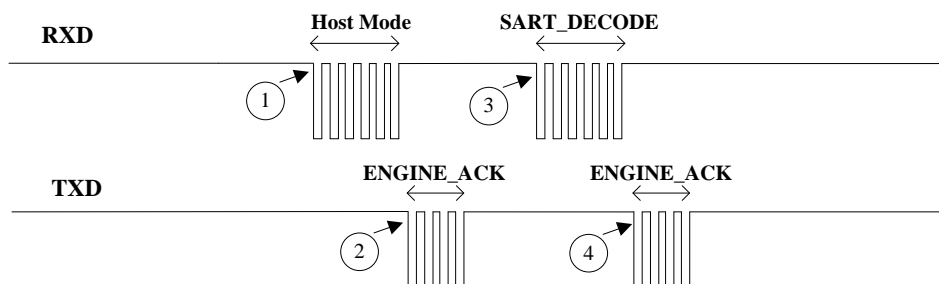

### 2-6-6 Case 6: Start decode after pulling down WAKE pin

Assuming that the engine is in Sleep Power state, host pulls down the WAKE pin to awaken engine and then sends a STRAT\_DECODE command.

- ① Host pulls down the WAKE pin.
- ② After more than 25 ms, host sends a command (0x09 0xD6 0x04 0x00 0x00 0x01 0x91 0x01 0x05 0xFE 0x85) to switch the trigger mode to be Host mode. If engine currently operates in Host mode, this step can be ignored.
- ③ After receiving the command, the engine returns an ENGINE\_ACK command (0x00 0x05 0xD0 0x00 0x00 0xFF 0xFF 0xFF 0x2B).
- ④ Host sends a STRAT\_DECODE command (0x04 0xE4 0x04 0x00 0xFF 0x14).
- ⑤ After receiving the command, the engine returns an ENGINE\_ACK command and then starts to decode.

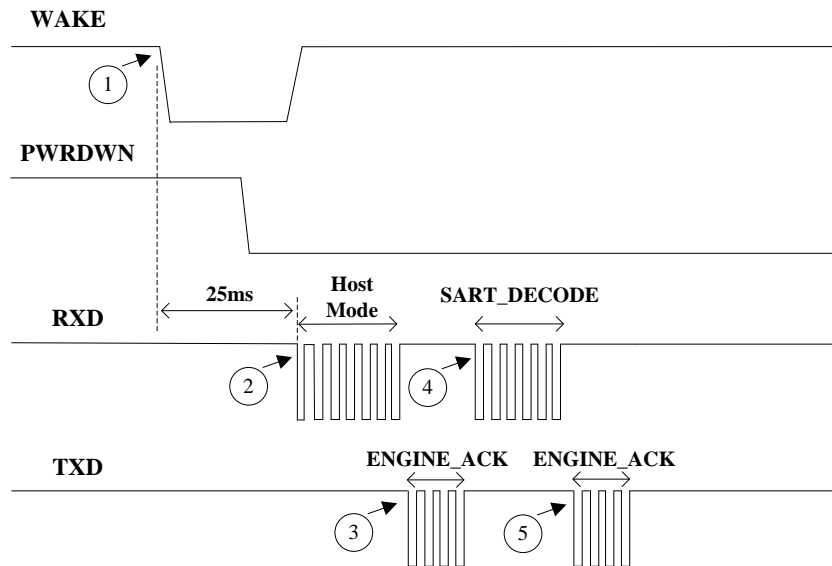

Assuming that the engine is in Awake Power state, host sends a STRAT\_DECODE command.

- ① Host sends a command (0x09 0xD6 0x04 0x00 0x00 0x01 0x91 0x01 0x05 0xFE 0x85) to switch the trigger mode to be Host mode. If engine currently operates in Host mode, this step can be ignored.
- ② After receiving the command, the engine returns an ENGINE\_ACK command (0x00 0x05 0xD0 0x00 0x00 0xFF 0xFF 0xFF 0x2B).
- ③ Host sends a STRAT\_DECODE command (0x04 0xE4 0x04 0x00 0xFF 0x14).
- ④ After receiving the command, the engine returns an ENGINE\_ACK command and then starts to decode.

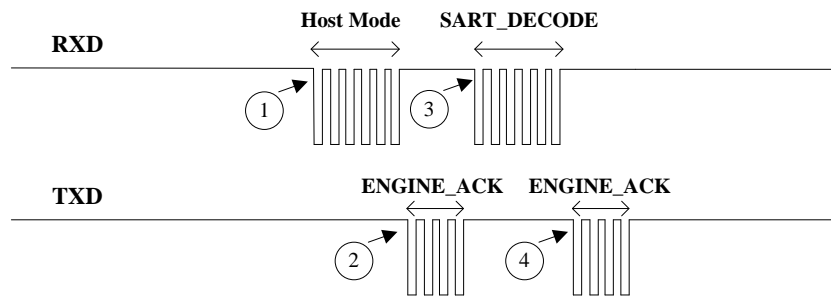

## 2-6-7 Case 7: Start decode after pulling down CTS pin

Assuming that the engine is in Sleep Power state, host pulls down the CTS pin to awaken engine and then sends a STRAT\_DECODE command.

- ① Host pulls down the CTS pin.
- ② After more than 25 ms, host sends a command (0x09 0xD6 0x04 0x00 0x00 0x01 0x91 0x01 0x05 0xFE 0x85) to switch the trigger mode to be Host mode. If engine currently operates in Host mode, this step can be ignored.
- ③ After receiving the command, the engine returns an ENGINE\_ACK command (0x00 0x05 0xD0 0x00 0x00 0xFF 0xFF 0xFF 0x2B).
- ④ Host sends a STRAT\_DECODE command (0x04 0xE4 0x04 0x00 0xFF 0x14).
- ⑤ After receiving the command, the engine returns an ENGINE\_ACK command and then starts to decode.

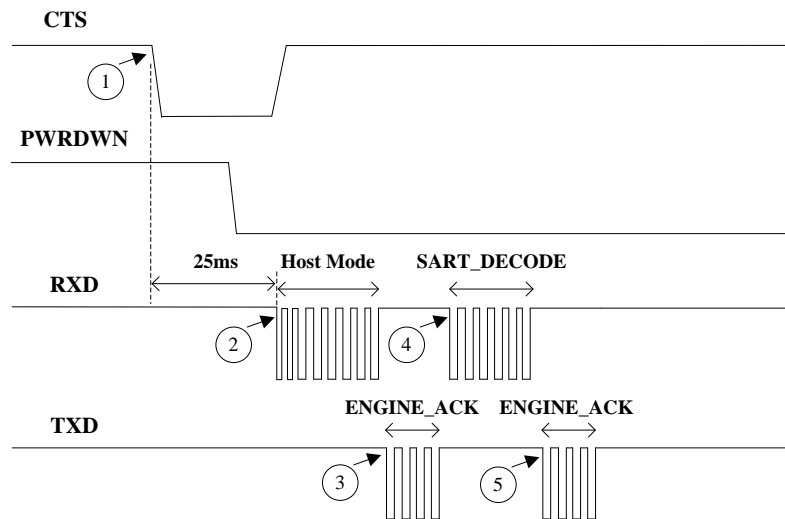

Assuming that the engine is in Awake Power state, host sends a STRAT\_DECODE command.

- ① Host sends a command (0x09 0xD6 0x04 0x00 0x00 0x01 0x91 0x01 0x05 0xFE 0x85) to switch the trigger mode to be Host mode. If engine currently operates in Host mode, this step can be ignored.
- ② After receiving the command, the engine returns an ENGINE\_ACK command (0x00 0x05 0xD0 0x00 0x00 0xFF 0xFF 0xFF 0x2B).
- ③ Host sends a STRAT\_DECODE command (0x04 0xE4 0x04 0x00 0xFF 0x14).
- ④ After receiving the command, the engine returns an ENGINE\_ACK command and then starts to decode.

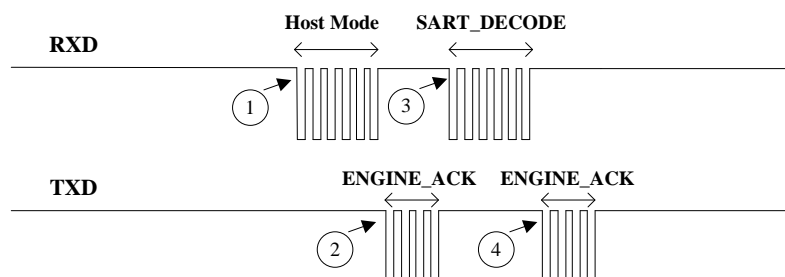



### 2-6-8 Case 8: Start decode after pulling down TRIG pin

Assuming that engine is in Sleep Power state, host pulls down TRIG pin to awaken engine to decode.

- ① Host keeps pulling down the TRIG pin.
- ② After about 25 ms, the engine awakes from Sleep Power state.
- ③ Then engine turns on the illumination LED and starts to decode. The illumination LED will be turned off if time-out is reached or engine succeeds in decoding a barcode.

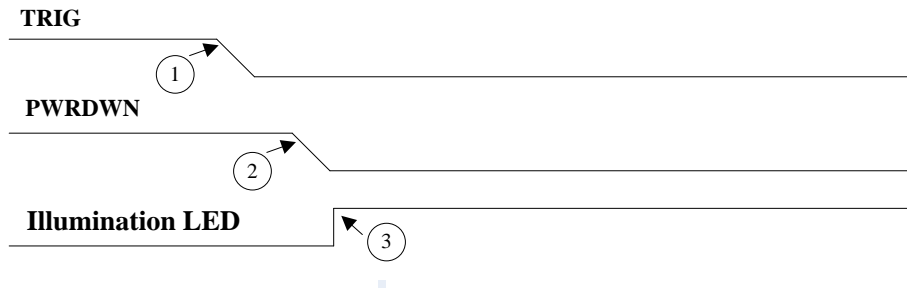

Assuming that the engine is in Awake Power state, host pulls down TRIG pin to decode.

- ① Host keeps pulling down the TRIG pin.
- ② Then engine turns on the illumination LED and starts to decode. The illumination LED will be turned off if time-out is reached or engine succeeds in decoding a barcode.

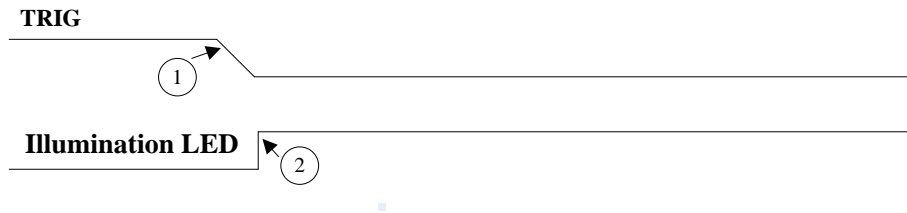

## 3 Parameter Menus

### 3-1 Introduction

This section describes the programmable parameters, to change the parameter values:

- ✚ Refer to [3-2 Single-parameter setting by scanning 1D barcodes](#) and [3-3 Multiple-parameter setting by scanning a QR code barcode](#), scan the appropriate barcodes included in this section, the new values replace the existing values.
- ✚ To set the new values as customer default settings, scan the Write to Customer Defaults barcode. The factory default settings or customer default settings can be recalled by scanning appropriate barcodes, refer to [12 Return default parameters & firmware version](#).
- ✚ Send parameters through the SCI. Instructions of SCI, refer to [4 Serial Communication Interface \(SCI\)](#).

### 3-2 Single-parameter setting by scanning 1D barcodes

Important notes:

- 1) During the process of programming, LED is lighting to indicate the programming correctness. LED will go off if any incorrect programming operation performed.
- 2) After each successful programming, LED will go off and the engine will beep twice.
- 3) Throughout the programming barcode menus, the factory default settings are indicated with asterisks (\*).

Two programming modes have been provided as bellows:

#### ① Single-scan setting

- Scan the appropriate **Single-scan setting** (e.g. **%0101D00%**) according to the user's demand.

**Example:** to set **Flow control** to be XON/XOFF.

**Steps:** Scan the following barcode.



#### ② Multiple-scan setting

- Step 1. Scan the **Option barcode** (e.g. **%0101M%**) according to the user's demand.
- Step 2. To the right of the option barcode, the necessary alphanumeric inputs are listed. Scan two alphanumeric entries from **0** to **9** or **A** to **F**, refer to [13 Configuration alphanumeric entry barcode](#).
- Step 3. Repeat Step 2, if more user parameters input are required.
- Step 4. Scan the **%END%** barcode, listed on the lower left hand corner of each parameter setting part.

**Example:** to set **Flow control** to be XON/XOFF.

**Steps:** Scan the following barcodes in order.

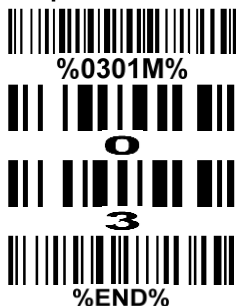

### 3-3 Multiple-parameter setting by scanning a QR code barcode

User can customize a QR code barcode to set multiple parameters. The engine can set multiple parameters by scanning this single QR code barcode.

1. The data format of the QR code barcode is as following.

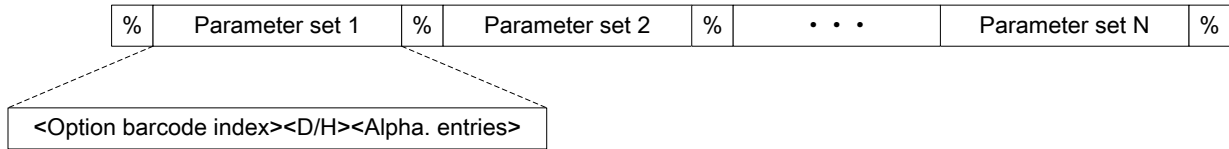

Note that:

- <Option barcode index> means the corresponding 4 digits of Option barcode.
- <D/H> means “D” or “H” character. “D” means that the type of alphanumeric entry is decimal; and “H” means that the type of alphanumeric entry is hexadecimal.
- <Alpha. entries> is a character string with various length of 2, 4, or other values.

**Example:** Set 0401->03 (decimal); 8002->0D0A (hexadecimal); 8202->01 (decimal). The customized QR code barcode contents and symbol are as following.

%0401D03%8002H0D0A%8202D01%



2. Notes of making QR code barcode

The model is chosen as M2. Other requirements, e.g. ECC level, Start mode, etc, are not specified.

3. Other notes

- The contents of a QR code barcode can include several same <Option barcode index> associated with same or different <Alpha. entries>. In the case of with different <Alpha. entries>, the latest <Alpha. entries> is the valid one.
- If any one of the parameter settings is invalid, the total setting is failed. The invalid setting can be caused by one of the following problems: invalid <Option barcode index>, invalid type of <D/H>, invalid type, length or value range of <Alpha. entries>, etc.

## 3-4 UART interface

### Flow control:

**None** – The communication only uses TXD and RXD signals without any hardware or software handshaking protocol.

**ACK/NAK** – After transmitting data, the engine expects either an <ACK> character (acknowledge) or <NAK> character response from the host. When a <NAK> character is received, the engine transmits the same data again and waits for either an <ACK> character or <NAK> character. After three unsuccessful attempts to send data when <NAK> characters are received the engine issues an error indication and discards the data.

**Inter-character delay:** This delay is inserted after each data character transmitted.

**Response delay:** This delay is used for serial communication of the engine when it waits for a handshaking acknowledgment from the host.

### Decode data packet format:

**Raw** – Engine sends raw decoded data directly.

**Packeted** – The decoded data is sent in data packet (see [4-2-3 DECODE\\_DATA](#)).

Multiple-scan setting				Single-scan setting
Option barcode	Para. code	Option	Para. value	
Flow control  %0301M%	0x01 0x2D	None	00*	 %0301D00% *
		ACK/NAK	06	 %0301D06%
Inter-character delay  %0302M%	0x01 0x2E	0 ms	00*	 %0302D00% *
		5 ms	01	 %0302D01%
		10 ms	02	 %0302D02%
		20 ms	03	 %0302D03%
		40 ms	04	 %0302D04%
		80 ms	05	 %0302D05%
Response delay  %0304M%	0x01 0x30	00-99 (100 ms)	00-99	
			00*	 %0304D00% *
Baudrate  %0305M%	0x01 0x31	300	00	 %0305D00%
		600	01	 %0305D01%
		1200	02	 %0305D02%
		2400	03	 %0305D03%
		4800	04	 %0305D04%
		9600	05*	 %0305D05% *
		19200	06	 %0305D06%
		38400	07	 %0305D07%
		57600	08	 %0305D08%
		115200	09	 %0305D09%

Multiple-scan setting				Single-scan setting
Option barcode	Para. code	Option	Para. value	
Parity bit  %0306M%	0x01 0x32	None	00*	 %0306D00% *
		Odd	01	 %0306D01%
		Even	02	 %0306D02%
Data bit  %0307M%	0x01 0x33	8 bits	00*	 %0307D00% *
		7 bits	01	 %0307D01%
Stop bit  %0308M%	0x01 0x34	1 bit	00*	 %0308D00% *
		2 bits	01	 %0308D01%
Decode data packet format  %0311M%	0x01 0x37	Raw	00*	 %0311D00% *
		Packeted	01*	 %0311D01%

  
 %END%

### 3-5 Scan mode & some global settings

#### Scan mode:

**Good-read off** – The trigger (Pin-12 TRIG) must be pulled down once to activate scanning. The engine stops scanning when there is a successful reading or no code is decoded after the **Scan standby duration** elapsed.

**Momentary** – Pin TRIG acts as a switch. Pull down pin TRIG to activate scanning and pull up the trigger to stop scanning. The light source of the engine stops scanning when there is a successful reading or no code is decoded after the **Scan standby duration** elapsed.

**Timeout off** – Pin TRIG must be pulled down once to activate scanning. The engine stops scanning when there is a successful reading.

**Host** – A START\_DECODE command issues the triggering signal. In this mode, the engine interprets an actual trigger pull as a **Good-read off** triggering option.

**Auto-detection- Good-read off** – By setting Enable, the scanner will start scanning if any nearby object has been detected. The scanner will stop scanning when there is a successful reading or no code is decoded after the **Stand-by duration** elapsed. Once the scanner stops scanning, the present object must be removed to enable **Auto-detection**.

**Scan standby duration:** Pin TRIG pulled or command sent by Host activates scanning. The engine stops scanning when no code is successful decoded after this duration elapsed.

**Multiple confirm:** If it is enabled, the engine will require a several times of same-decoded-data to confirm a valid reading.

**Global Max./Min. code length for 1D symbols:** These two lengths are defined as the valid range of decoded barcode data length. Make sure that the minimum length setting is no greater than the maximum length setting. When setting of minimum and maximum reading length is equal, the engine works as a fixed-length barcode decoder.

#### Notes:

- Please set the max./min. length for individual barcode in later chapters, if a special demand is requested.
- Both data and check digits contribute to code length.
- These two settings have no effect on the types of barcode with fixed-length, e.g. UPC-A, UPC-E, EAN-13 and China Post.

**Global G1-G6 string selection:** The engine offer one or two string group for all types of barcode. By setting one or two digits to indicate which string group you want to apply. You may refer to [3-41 String setting](#) and [3-40 G1-G4 string position & Code ID position](#).

Example: Group 1 → set 01 or 10. Group 2 and 4 → set 24 or 42.

All valid settings include 00, 01, 02, 03, 04, 05, 06, 10, 11, 12, 13, 14, 15, 16, 20, 21, 22, 23, 24, 25, 26, 30, 31, 32, 33, 34, 35, 36, 40, 41, 42, 43, 44, 45, 46, 50, 51, 52, 53, 54, 55, 56, 60, 61, 62, 63, 64, 65 and 66.

**Element amendment:** If it is enabled, the engine can read the barcode comprised with bars and spaces in different scales.

**Character output restraint:**



**Printable character only** - If this option is selected, the engine will output the printable characters only, i.e. in ASCII from 20H to 7EH.

















**Alphanumeric character only** - If this option is selected, the engine will output the alphanumeric characters only, i.e. "A"- "Z", "a"- "z", "0"- "9".

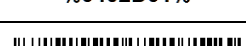
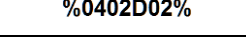
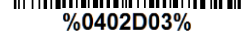



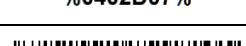
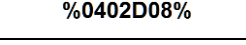
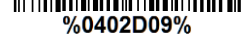



















**Decoder optimization:** If it is enabled, the engine will optimize the engine with error correction. This function is not effective for all types of barcode.















**Character encoding system:** A character encoding system consists of a code that pairs each character from a given repertoire. Common examples include Morse code, the Baudot code, the ASCII and Unicode. If the data received does not display with the proper characters (domestic language, e.g. Chinese), it maybe because the barcode being scanned was created using a character encoding system that is different from the one the host program is expecting. Try alternate options to find the proper one.

**Sleep mode:** If it is enabled, the engine will go to sleep when no code is successful decoded after the Sleep mode delay elapsed.

**Sleep mode delay:** When no code is successful decoded beyond this time, the engine will go to sleep.

Multiple-scan setting				Single-scan setting
Option barcode	Para. code	Option	Para. value	
Scan mode  %0401M%	0x01 0x91	Good-read off	00	 %0401D00%
		Momentary	01*	 %0401D01% *
		Timeout off	04	 %0401D04%
		Host	05	 %0401D05%
		Auto-detection- Good-read off	07	 %0401D07%
Scan standby duration  %0402M%	0x01 0x92	4 seconds	00*	 %0402D00% *
		8 seconds	01	 %0402D01%
		16 seconds	02	 %0402D02%
		24 seconds	03	 %0402D03%
		30 seconds	04	 %0402D04%
		1 minute	05	 %0402D05%
		1.5 minutes	06	 %0402D06%
		2 minutes	07	 %0402D07%
		5 minutes	08	 %0402D08%
		7 minutes	09	 %0402D09%
		10 minutes	10	 %0402D10%
		15 minutes	11	 %0402D11%
		20 minutes	12	 %0402D12%
		30 minutes	13	 %0402D13%
		45 minutes	14	 %0402D14%
1 hour	15	 %0402D15%		

Multiple-scan setting				Single-scan setting
Option barcode	Para. code	Option	Para. value	
Double confirm  %0404M%	0x01 0x94	00-09 (00: no)	00-09	
			00*	 %0404D00% *
Global max. code length for 1D symbols  %0405M%	0x01 0x95	04-99	04-99	
			99*	 %0405D99% *
Global min. code length for 1D symbols  %0406M%	0x01 0x96	01-99	01-99	
			04*	 %0406D04% *
Global G1-G6 string selection  %0407M%	0x01 0x97	00-66	00-66	
			00*	 %0407D00% *
Element amendment  %0408M%	0x01 0x98	Disable	00	 %0408D00%
		Enable	01*	 %0408D01% *
Character output restraint  %0409M%	0x01 0x99	None	00*	 %0409D00% *
		Printable characters only	01	 %0409D01%
		Alphanumeric characters only	02	 %0409D02%
Decoder optimization  %0410M%	0x01 0x9A	Disable	00	 %0410D00%
		Enable	01*	 %0410D01% *
Character encoding system  %0413M%	0x01 0x9D	ASCII	00*	 %0413D00% *
		UTF-8	01	 %0413D01%
		Windows-1251	02	 %0413D02%
		GBK	03	 %0413D03%
		Big 5	04	 %0413D04%

Multiple-scan setting				Single-scan setting
Option barcode	Para. code	Option	Para. value	
Sleep mode  %0416M%	0x01 0xA0	Disable	00	 %0416D00%
		Enable	01*	 %0416D01% *
Sleep mode delay  %0412M%	0x01 0x9C	1 second	00*	 %0412D00% *
		5 seconds	01	 %0412D01%
		10 seconds	02	 %0412D02%
		30 seconds	03	 %0412D03%
		60 seconds (1 minute)	04	 %0412D04%
		300 seconds (5 minutes)	05	 %0412D05%
		600 seconds (10 minutes)	06	 %0412D06%
		1800 seconds (30 minutes)	07	 %0412D07%
		3600 seconds (1 hour)	08	 %0412D08%
		10800 seconds (3 hours)	09	 %0412D09%

  
 %END%

### 3-6 Indication





**Power on alert:** After power-on the engine will generate an alert signal to indicate a successful self-test.

**LED indication:** After each successful reading, the DLED signal will assert to indicate a good barcode reading.

**Beeper indication:** After each successful reading, the engine will beep to indicate a good barcode reading, and its beep tone duration is adjustable.

**Beep tone duration:** This parameter can be adjusted for a good reading upon favorite usage.

**Volume of beeper:** This parameter can be adjusted for different level of the volume of the beeper.

















Multiple-scan setting				Single-scan setting
Option barcode	Para. code	Option	Para. value	
Power on alert  %0501M%	0x01 0xF5	Disable	00	 %0501D00%
		Enable	01*	 %0501D01% *
LED indication  %0502M%	0x01 0xF6	Disable	00	 %0502D00%
		Enable	01*	 %0502D01% *
Beeper indication  %0503M%	0x01 0xF7	Disable	00	 %0503D00%
		Enable	01*	 %0503D01% *
Beep tone duration  %0504M%	0x01 0xF8	01-09 (25 ms)	01-09	
			03*	 %0504D03% *
Volume of beeper  %0505M%	0x01 0xF9	Low	00	 %0505D00%
		Middle	01	 %0505D01%
		High	02*	 %0505D02% *
 %END%				

### 3-7 Decode illumination mode and Decode aiming pattern

**Decode illumination mode:** Enable illumination causes the engine to turn on the illumination to aid decoding. Disable illumination to turn off illumination for the engine during decoding. Better quality images could be obtained with illumination support. The effectiveness of the illumination decreases as the distance to the target increases.

**Decode aiming pattern:** When this option is enabled, the engine will project the aiming pattern during the code capture.

**Level of decode illumination:** This parameter can be adjusted for different level of decode illumination.

Multiple-scan setting				Single-scan setting
Option barcode	Para. code	Option	Para. value	
Decode illumination mode  %9001M%	0x23 0x29	Always Off	00	 %9001D00%
		Always On	01	 %9001D01%
		Flashing	02*	 %9001D02% *
		On when reading	03	 %9001D03%
Decode aiming pattern  %9002M%	0x23 0x2A	Always off	00	 %9002D00%
		Always on	01	 %9002D01%
		On before reading	02	 %9002D02%
		On when reading	03*	 %9002D03% *
Level of decode illumination  %9003M%	0x23 0x2B	Disable decode illumination	00	 %9003D00%
		Low	01	 %9003D01%
		Middle	02*	 %9003D02% *
		High	03	 %9003D03%
 %END%				

### 3-8 Other settings























**1D symbols read:** A global setting of 1D symbols readability.

**2D symbols read:** A global setting of 2D symbols readability.

**Multi-symbols read:** By setting Enable, the engine allows to read multiple symbols in one image. By setting Disable, the engine will only read the symbol closest to the center area in the image.

**Vertical centering read:** By setting enable, the engine reads only the barcode centered by the aimer in vertical direction. However, the engine will read either one of two barcodes which are positioned horizontally.

**Mobile screen read:** By setting enable, the engine can read barcodes on a mobile screen better. However, this will slow the reading speed of normal barcodes a little bit.

Multiple-scan setting				Single-scan setting
Option barcode	Para. code	Option	Para. value	
1D symbols read  %1005M%	0x03 0xED	Follow respective 1D symbol setting	00*	 %1005D00% *
		All 1D Disable	01	 %1005D01%
2D symbols read  %1001M%	0x03 0xE9	Follow respective 2D symbol setting	00*	 %1001D00% *
		All 2D Disable	01	 %1001D01%
		All 2D Enable	02	 %1001D02%
		Only PDF417 Enable	03	 %1001D03%
		Only QR code Enable	04	 %1001D04%
		Only Data Matrix Enable	05	 %1001D05%
		Only MaxiCode Enable	06	 %1001D06%
		Only Aztec Code Enable	07	 %1001D07%
		Only Han Xin Code Enable	08	 %1001D08%
Multi-symbols read  %1003M%	0x03 0xEB	Disable	00*	 %1003D00% *
		Enable	01	 %1003D01%
Vertical centering read  %1004M%	0x03 0xEC	Disable	00*	 %1004D00% *
		Enable	01	 %1004D01%
Mobile screen read  %1007M%	0x03 0xEF	Disable	00	 %1007D00%
		Enable	01*	 %1007D01% *





**Note: The instruction of calibrating the aimer in vertical centering direction.**

1. Scan the barcode (“%initD00%”) on this page. The engine will give three musical short beeps to indicate entering calibration mode.
2. Press the trigger of the engine while maintaining the distance of about 15cm between the scan window of the engine and this paper. After a few seconds, the engine will give three short beeps to indicate a successful calibration, or a long beep to indicate a failed calibration.
3. If the calibration is failed in step 2, please repeat the steps 1-2. If it is not succeed after a multiple times of calibration, please contact your local dealer or the manufacturer for further instruction.



### 3-9 UPC-A

**Read:**

Format

System character	Data digits (10 digits)	Check digit
------------------	-------------------------	-------------

**Check digit verification:** The check digit is optional.

**Check digit trans.:** By setting Enable, check digit will be transmitted.

**Code id setting:** Code ID is a one-two-character string used to represent the symbol upon a succeeding reading. If you want application to transmit Code ID, you must set **Code ID transmission** to be enabled. Refer to [3-41 String transmission](#).

**Insertion group selection:** Refer to Global insertion group selection of [3-5 Scan mode & some global settings](#).

**Supplement digits:** The Supplement digits barcode is the supplemental 2 of 5 characters.

Format

System character	Data digits (10 digits)	Check digit	Supplement digits 2 of 5
------------------	-------------------------	-------------	--------------------------

**Truncation/Expansion:**

**Truncate leading zeros** - The leading “0” digits of UPC-A data characters can be truncated when the feature is enabled.

Example: Barcode “001234567895”,

Output: “1234567895”.

**Expand to EAN-13** - It extends to 13-digits with a “0” leading digit when the feature is enabled.

Example: Barcode “001234567895”,

Output: “0001234567895”.

**Truncate system character** - The system character of UPC-A data can be truncated when the feature is enabled.

























Example: Barcode “001234567895”,

Output: “01234567895”.

**Add country code** - The country code (“0” for USA) can be added when the feature is enabled.

Example: Barcode “001234567895”,

Output: “0001234567895”.

Multiple-scan setting				Single-scan setting
Option barcode	Para. code	Option	Para. value	
Read  %1101M%	0x04 0x4D	Disable	00	 %1101D00%
		Enable	01*	 %1101D01% *
Check digit verification  %1102M%	0x04 0x4E	Disable	00	 %1102D00%
		Enable	01*	 %1102D01% *
Check digit trans.  %1103M%	0x04 0x4F	Disable	00	 %1103D00%
		Enable	01*	 %1103D01% *
Code ID setting  %1104M%	0x04 0x50	00-FF <sub>16</sub> (ASCII)	00-FF <sub>16</sub>	
			<A>*	 %1104H41% *
Insert group selection  %1105M%	0x04 0x51	00-66	00-66	
			00*	 %1105D00% *
Supplement digits  %1106M%	0x04 0x52	None	00*	 %1106D00% *
		2 digits	01	 %1106D01%
		5 digits	02	 %1106D02%
		2 or 5 digits	03	 %1106D03%
Truncation/Expansion  %1107M%	0x04 0x53	None	00*	 %1107D00% *
		Truncate leading zeros	01	 %1107D01%
		Expand to EAN-13	02	 %1107D02%
		Truncate system character	03	 %1107D03%
		Add country code	04	 %1107D04%

  
%END%

### 3-10 UPC-E

**Read:**

Format

System character "0"	Data digits (6 digits)	Check digit
----------------------	------------------------	-------------

**Check digit verification:** The check digit is optional.

**Check digit trans.:** By setting Enable, check digit will be transmitted.

**Code id setting:** Refer to 

Code ID setting
-----------------

 of [3-9 UPC-A](#).

**Insertion group selection:** Refer to 

Insertion group selection
---------------------------

 of [3-9 UPC-A](#).

**Supplement digits:**

Format

System character "0"	Data digits (6 digits)	Check digit	Supplement digits 2 of 5
----------------------	------------------------	-------------	--------------------------

**Truncation/Expansion:**

**Truncate leading zeros** - The leading "0" digits of UPC-E data characters can be truncated when the feature is enabled.

Example: Barcode "00123457",

Output: "123457".

**Expand to EAN-13** - It extends to 13-digits with a "0" leading digit when the feature is enabled.

Example: Barcode "00123457",

Output: "0001234000057".

**Expand to UPC-A** - It extends to 12-digits when the feature is set to be enabled.

Example: Barcode "00123457",

Output: "001234000057".

**Truncate system character** - The system character "0" of UPC-E data can be truncated when the feature is enabled.

























Example: Barcode "00123457",

Output: "0123457".

**Add country code** - The country code ("0" for USA) can be added when the feature is enabled.

Example: Barcode "00123457",

Output: "000123457".

Multiple-scan setting				Single-scan setting
Option barcode	Para. code	Option	Para. value	
Read  %1201M%	0x04 0xB1	Disable	00	 %1201D00%
		Enable	01*	 %1201D01% *
Check digit verification  %1202M%	0x04 0xB2	Disable	00	 %1202D00%
		Enable	01*	 %1202D01% *
Check digit trans.  %1203M%	0x04 0xB3	Disable	00	 %1203D00%
		Enable	01*	 %1203D01% *
Code ID setting  %1204M%	0x04 0xB4	00-FF <sub>16</sub> (ASCII)	00-FF <sub>16</sub>	
			<D>*	 %1204H44% *
Insert group selection  %1205M%	0x04 0xB5	00-66	00-66	
			00*	 %1205D00% *
Supplement digits  %1206M%	0x04 0xB6	None	00*	 %1206D00% *
		2 digits	01	 %1206D01%
		5 digits	02	 %1206D02%
		2 or 5 digits	03	 %1206D03%
Truncation/Expansion  %1207M%	0x04 0xB7	None	00*	 %1207D00% *
		Truncate leading zeros	01	 %1207D01%
		Expand to EAN-13	02	 %1207D02%
		Expand to UPC-A	03	 %1207D03%
		Truncate system character	04	 %1207D04%
		Add country code	05	 %1207D05%

  
%END%

### 3-11 UPC-E1

**Read:**

Format

Leading zero	Data digits (6 digits)	Check digit
--------------	------------------------	-------------

**Check digit verification:** The check digit is optional.

**Check digit trans.:** By setting Enable, check digit will be transmitted.

**Code id setting:** Refer to 

Code ID setting
-----------------

 of [3-9 UPC-A](#).

**Insertion group selection:** Refer to 

Insertion group selection
---------------------------

 of [3-9 UPC-A](#).

**Supplement digits:**

Format

Leading zero	Data digits (6 digits)	Check digit	Supplement digits 2 of 5
--------------	------------------------	-------------	--------------------------

**Truncation/Expansion:**

**Expand to EAN -13** - It extends to 13-digits with “0” digits when the feature is enabled.

Example: Barcode “10012341”,

Output: “0100120000031”.

**Expand to UPC-A** - It extends to 12-digits when the feature is set to be enabled.

Example: Barcode “10012341”,

Output: “100120000031”.

**Truncate system character** - The system character “1” of UPC-E1 data can be truncated when the feature is enabled.

Example: Barcode “10012341”,

Output: “0012341”.

**Add country code** - The country code (“0” for USA) can be added when the feature is enabled.

Example: Barcode “10012341”,

Output: “010012341”.

Multiple-scan setting				Single-scan setting
Option barcode	Para. code	Option	Para. value	
Read  %3401M%	0x0D 0x49	Disable	00*	 %3401D00% *
		Enable	01	 %3401D01%
Check digit verification  %3402M%	0x0D 0x4A	Disable	00	 %3402D00%
		Enable	01*	 %3402D01% *
Check digit trans.  %3403M%	0x0D 0x4B	Disable	00	 %3403D00%
		Enable	01*	 %3403D01% *
Code ID setting  %3404M%	0x0D 0x4C	00-FF <sub>16</sub> (ASCII)	00-FF <sub>16</sub>	
			<D>*	 %3404H44% *
Insert group selection  %3405M%	0x0D 0x4D	00-66	00-66	
			00*	 %3405D00% *
Supplement digits  %3406M%	0x0D 0x4E	None	00*	 %3406D00% *
		2 digits	01	 %3406D01%
		5 digits	02	 %3406D02%
		2 or 5 digits	03	 %3406D03%
Truncation/Expansion  %3407M%	0x0D 0x4F	None	00*	 %3407D00% *
		Expand to EAN-13	02	 %3407D02%
		Expand to UPC-A	03	 %3407D03%
		Truncate system character	04	 %3407D04%
		Add country code	05	 %3407D05%

  
%END%

### 3-12 EAN-13

**Read:**

Format

Data digits (12 digits)	Check digit
-------------------------	-------------

**Check digit verification:** The check digit is optional.

**Check digit trans.:** By setting Enable, check digit will be transmitted.

**Code id setting:** Refer to 

Code ID setting
-----------------

 of [3-9 UPC-A](#).

**Insertion group selection:** Refer to 

Insertion group selection
---------------------------

 of [3-9 UPC-A](#).

**Supplement digits:**

Format

Data digits (12 digits)	Check digit	Supplement digits 2 of 5
-------------------------	-------------	--------------------------

**ISBN/ISSN:** The ISBN (international Standard Book Number, or Bookland EAN) and ISSN (International Standard Serial Number) are two kinds of barcode for books and magazines. The ISBN is 10 digits with leading “978” and the ISSN is 8 digits with leading “977” of the EAN-13.

Example:

Barcode “9780194315104”, Output: “019431510X”.























Barcode “9771005180004”, Output: “10051805”.

**ISBN/ISSN code ID setting:** Refer to 

Code ID setting
-----------------

 of [3-9 UPC-A](#).



Multiple-scan setting				Single-scan setting
Option barcode	Para. code	Option	Para. value	
Read  %1301M%	0x05 0x15	Disable	00	 %1301D00%
		Enable	01*	 %1301D01% *
Check digit verification  %1302M%	0x05 0x16	Disable	00	 %1302D00%
		Enable	01*	 %1302D01% *
Check digit trans.  %1303M%	0x05 0x17	Disable	00	 %1303D00%
		Enable	01*	 %1303D01% *
Code ID setting  %1304M%	0x05 0x18	00-FF <sub>16</sub> (ASCII)	00-FF <sub>16</sub>	
			<D>*	 %1304H41% *
Insert group selection  %1305M%	0x05 0x19	00-66	00-66	
			00*	 %1305D00% *
Supplement digits  %1306M%	0x05 0x1A		None	 %1306D00% *
			2 digits	 %1306D01%
			5 digits	 %1306D02%
			2 or 5 digits	 %1306D03%
ISBN/ISSN conversion  %1307M%	0x05 0x1B	Disable	00*	 %1307D00% *
		Enable	01	 %1307D01%
ISBN/ISSN code ID setting  %1309M%	0x05 0x1C	00-FF <sub>16</sub> (ASCII)	00-FF <sub>16</sub>	
			<B>*	 %1309H42% *

  
 %END%

### 3-13 EAN-8

**Read:**

Format

Data digits (7 digits)	Check digit
------------------------	-------------

**Check digit verification:** The check digit is optional.

**Check digit trans.:** By setting Enable, check digit will be transmitted.

**Code id setting:** Refer to 

Code ID setting
-----------------

 of [3-9 UPC-A](#).

**Insertion group selection:** Refer to 

Insertion group selection
---------------------------

 of [3-9 UPC-A](#).

**Supplement digits:**









Format

Data digits (8 digits)	Check digit	Supplement digits 2 of 5
------------------------	-------------	--------------------------

**Truncation/Expansion:** Refer to 

Truncation/Expansion
----------------------

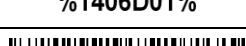
 of [3-9 UPC-A](#).

Multiple-scan setting				Single-scan setting	
Option barcode	Para. code	Option	Para. value		
Read  %1401M%	0x05 0x79	Disable	00	 %1401D00%	
		Enable	01*	 %1401D01% *	
Check digit verification  %1402M%	0x05 0x7A	Disable	00	 %1402D00%	
		Enable	01*	 %1402D01% *	
Check digit trans.  %1403M%	0x05 0x7B	Disable	00	 %1403D00%	
		Enable	01*	 %1403D01% *	
Code ID setting  %1404M%	0x05 0x7C	00-FF <sub>16</sub> (ASCII)	00-FF <sub>16</sub>		
			<C>*	 %1404H43% *	
Insert group selection  %1405M%	0x05 0x7D	00-66	00-66		
			00*	 %1405D00% *	
Supplement digits  %1406M%	0x05 0x7E		None	 %1406D00% *	
			2 digits	01	 %1406D01%
			5 digits	02	 %1406D02%
			2 or 5 digits	03	 %1406D03%
Truncation/Expansion  %1407M%	0x05 0x7F		None	 %1407D00% *	
			Truncate leading zero	01	 %1407D01%
			Expand to EAN-13	02	 %1407D02%

  
 %END%

### 3-14 Code 39 (Code 32, Trioptic Code 39)

Read:

Format

Start character (*)	Data digits (variable)	Check digit (optional)	End character (*)
---------------------	------------------------	------------------------	-------------------

**Check digit verification:** The check digit is optional and made as the sum module 43 of the numerical value of the data digits.

**Check digit trans.:** By setting Enable, check digit will be transmitted.

**Max./Min. code length:** Each symbol has own max./min. code length. If both setting of max./min. code length are "00", the setting of global max./min. code length is effective. The length is defined as to the actual barcode data length to be sent. Label with length exceeds these limits will be rejected. Make sure that the minimum length setting is no greater than the maximum length setting or otherwise all labels of the symbol will bet be readable. In particular, you can see the same value for both minimum and maximum reading length to force the fixed length barcode decoded.

**Code id setting:** Refer to 

Code ID setting
-----------------

 of [3-9 UPC-A](#).

**Insertion group selection:** Refer to 

Insertion group selection
---------------------------

 of [3-9 UPC-A](#).

**Start/End transmission:** the start and end characters of Code 39 are "\*". You can transmit all data digits including two "\*".

**"\*" as data character:** by setting Enable, "\*" can be recognized as data character.

**Convert Code 39 to Code 32:** Code 32 is a variant of Code 39 used by the Italian pharmaceutical industry. Note that code 39 must be enabled in order for this parameter to function.

Format of Code 32

"A" (optional)	Data digits (8 digits)	Check digit
----------------	------------------------	-------------

**Code 32 Prefix "A" transmission:** By setting Enable, the prefix character "A" can be added to all Code 32 barcodes.















**Trioptic Code 39 read:** Trioptic Code 39 is a variant of Code 39 used in the marking of magnetic tapes and computer cartridges. Trioptic Code 39 symbols always contain six characters.

Format

Start character ( \$ )	Data digits (8 digits)	End character ( \$ )
------------------------	------------------------	----------------------

**Trioptic Code 39 Start/End transmission:** The start and end characters of Trioptic Code 39 are "\$". All data digits including two "\$" can be transmitted.

Multiple-scan setting				Single-scan setting
Option barcode	Para. code	Option	Para. value	
Read  %1501M%	0x05 0xDD	Disable	00	 %1501D00%
		Enable	01*	 %1501D01% *
Check digit verification  %1502M%	0x05 0xDE	Disable	00	 %1502D00%
		Enable	01*	 %1502D01% *
Check digit trans.  %1503M%	0x05 0xDF	Disable	00	 %1503D00%
		Enable	01*	 %1503D01% *
Max. code length  %1504M%	0x05 0xE0	00-99	00-99	
			99*	 %1504D99% *
Min. code length  %1505M%	0x05 0xE1	00-99	00-99	
			01*	 %1505D01% *
Code ID setting  %1506M%	0x05 0xE2	00-FF <sub>16</sub> (ASCII)	00-FF <sub>16</sub>	
			<M>*	 %1506H4D% *
Insert group selection  %1507M%	0x05 0xE3	00-66	00-66	
			00*	 %1507D00% *
Format  %1508M%	0x05 0xE4	Standard	00*	 %1508D00% *
		Full ASCII	01	 %1508D01%
Start/End transmission  %1509M%	0x05 0xE5	Disable	00*	 %1509D00%
		Enable	01	 %1509D01% *
“*” as data character %1510M%	0x05 0xE6	Disable	00*	 %1510D00% *

Multiple-scan setting				Single-scan setting
Option barcode	Para. code	Option	Para. value	
 %1510M%		Enable	01	 %1510D01%
Convert Code 39 to Code 32  %1511M%	0x05 0xE7	Disable	00*	 %1511D00% *
		Enable	01	 %1511D01%
Code 32 prefix "A" transmission  %1512M%	0x05 0xE8	Disable	00*	 %1512D00% *
		Enable	01	 %1512D01%
Trioptic Code 39 read  %1513M%	0x05 0xE9	Disable	00*	 %1513D00% *
		Enable	01	 %1513D01%
Trioptic Code 39 Start/End transmission  %1514M%	0x05 0xEA	Disable	00*	 %1514D00% *
		Enable	01	 %1514D01%

  
%END%

### 3-15 Interleaved 2 of 5

**Read:**

Format

Data digits (variable)	Check digit (optional)
------------------------	------------------------

**Check digit verification:** The check digit is made as the sum module 10 of the numerical value of the data digits. There are two optional check digit algorithms: the specified Uniform Symbol Specification (USS) and the Optical Product Code Council (OPCC).

**Check digit trans.:** By setting Enable, check digit will be transmitted.

**Max./Min. code length:** Refer to 

Max./Min. code length
-----------------------

 of [3-14 Code 39 \(Code 32, Trioptic Code 39\)](#).

**Code id setting:** Refer to 



















Code ID setting
-----------------

 of [3-9 UPC-A](#).

**Insertion group selection:** Refer to 

Insertion group selection
---------------------------

 of [3-9 UPC-A](#).

Multiple-scan setting				Single-scan setting
Option barcode	Para. code	Option	Para. value	
Read  %1601M%	0x06 0x41	Disable	00	 %1601D00%
		Enable	01*	 %1601D01% *
Check digit verification  %1602M%	0x06 0x42	Disable	00*	 %1602D00% *
		USS	01	 %1602D01%
		OPCC	02	 %1602D02%
Check digit trans.  %1603M%	0x06 0x43	Disable	00*	 %1603D00% *
		Enable	01	 %1603D01%
Max. code length  %1604M%	0x06 0x44	00-99	00-99	
			99*	 %1604D99% *
Min. code length  %1605M%	0x06 0x45	00-99	00-99	
			06*	 %1605D06% *
Code ID setting  %1606M%	0x06 0x46	00-FF <sub>16</sub> (ASCII)	00-FF <sub>16</sub>	
			< >*	 %1606H49% *
Insert group selection  %1607M%	0x06 0x47	00-66	00-66	
			00*	 %1607D00% *

  
 %END%



### 3-16 Industrial 2 of 5

Read:

Format

Data digits (variable)

Max./Min. code length: Refer to Max./Min. code length of 3-14 Code 39 (Code 32, Trioptic Code 39).

Code id setting: Refer to Code ID setting of 3-9 UPC-A.

Insertion group selection: Refer to Insertion group selection of 3-9 UPC-A.

Multiple-scan setting				Single-scan setting
Option barcode	Para. code	Option	Para. value	
Read  %1701M%	0x06 0xA5	Disable	00*	 %1701D00% *
		Enable	01	 %1701D01%
Max. code length  %1702M%	0x06 0xA6	00-99	00-99	
			99*	 %1702D99% *
Min. code length  %1703M%	0x06 0xA7	00-99	00-99	
			04*	 %1703D04% *
Code ID setting  %1704M%	0x06 0xA8	00-FF <sub>16</sub> (ASCII)	00-FF <sub>16</sub>	
			<H>*	 %1704H48% *
Insert group selection  %1705M%	0x06 0xA9	00-66	00-66	
			00*	 %1705D00% *

  
 %END%

### 3-17 Matrix 2 of 5

**Read:**

Format

Data digits (variable)	Check digit (optional)
------------------------	------------------------

**Check digit verification:** The check digit is made as the sum module 10 of the numerical value of the data digits.

**Check digit trans.:** By setting Enable, check digit will be transmitted.

**Max./Min. code length:** Refer to 

Max./Min. code length
-----------------------

 of [3-14 Code 39 \(Code 32, Trioptic Code 39\)](#).

**Code id setting:** Refer to 

Code ID setting
-----------------

 of [3-9 UPC-A](#).

**Insertion group selection:** Refer to 

Insertion group selection
---------------------------

 of [3-9 UPC-A](#).

Multiple-scan setting				Single-scan setting
Option barcode	Para. code	Option	Para. value	
Read  %1801M%	0x07 0x09	Disable	00	 %1801D00%
		Enable	01*	 %1801D01% *
Check digit verification  %1802M%	0x07 0x0A	Disable	00*	 %1802D00% *
		Enable	01	 %1802D01%
Check digit trans.  %1803M%	0x07 0x0B	Disable	00*	 %1803D00% *
		Enable	01	 %1803D01%
Max. code length  %1804M%	0x07 0x0C	00-99	00-99	
			99*	 %1804D99% *
Min. code length  %1805M%	0x07 0x0D	00-99	00-99	
			06*	 %1805D06% *
Code ID setting  %1806M%	0x07 0x0E	00-FF <sub>16</sub> (ASCII)	00-FF <sub>16</sub>	
			<X>*	 %1806H58% *
Insert group selection  %1807M%	0x07 0x0F	00-66	00-66	
			00*	 %1807D00% *

  
 %END%

### 3-18 Codabar

**Read:**

Format

Start character	Data digits (variable)	Check digit (optional)	End character
-----------------	------------------------	------------------------	---------------

**Check digit verification:** The check digit is made as the sum module 16 of the numerical value of the data digits.

**Check digit trans.:** By setting Enable, check digit will be transmitted.

**Max./Min. code length:** Refer to **Max./Min. code length** of [3-14 Code 39 \(Code 32, Trioptic Code 39\)](#).

**Code id setting:** Refer to **Code ID setting** of [3-9 UPC-A](#).















**Insertion group selection:** Refer to **Insertion group selection** of [3-9 UPC-A](#).

**Start/End Type:** Codabar has four pairs of Start/End Pattern; you may select one pair to match your application.

**Start/End transmission:** Refer to **Start/End transmission** of [3-14 Code 39 \(Code 32, Trioptic Code 39\)](#).

**Start/End character equality:** By setting Enable, the start and end character of a Codabar barcode must be the same.

Multiple-scan setting				Single-scan setting
Option barcode	Para. code	Option	Para. value	
Read  %1901M%	0x07 0x6D	Disable	00	 %1901D00%
		Enable	01*	 %1901D01% *
Check digit verification  %1902M%	0x07 0x6E	Disable	00*	 %1902D00% *
		Enable	01	 %1902D01%
Check digit trans.  %1903M%	0x07 0x6F	Disable	00*	 %1903D00% *
		Enable	01	 %1903D01%
Max. code length  %1904M%	0x07 0x70	00-99	00-99	
			99*	 %1904D99% *
Min. code length  %1905M%	0x07 0x71	00-99	00-99	
			04*	 %1905D04% *

Multiple-scan setting				Single-scan setting
Option barcode	Para. code	Option	Para. value	
Code ID setting  %1906M%	0x07 0x72	00-FF <sub>16</sub> (ASCII)	00-FF <sub>16</sub>	 %1906H4E% *
			<N>*	
Insert group selection  %1907M%	0x07 0x73	00-66	00-66	 %1907D00% *
			00*	
Start/End type  %1908M%	0x07 0x74	ABCD/ABCD	00*	 %1908D00% *
		abcd/abcd	01	 %1908D01%
		ABCD/TN*E	02	 %1908D02%
		abcd/tn*E	03	 %1908D03%
Start/End transmission  %1909M%	0x07 0x75	Disable	00*	 %1909D00% *
		Enable	01	 %1909D01%
Start/End character equality  %1910M%	0x07 0x76	Disable	00*	 %1910D00% *
		Enable	01	 %1910D01%

  
 %END%

## 3-19 Code 128

**Read:**

Format

Data digits (variable)	Check digit (optional)
------------------------	------------------------

**Check digit verification:** The check digit is made as the sum module 103 of all data digits.

**Check digit trans.:** By setting Enable, check digit will be transmitted.

**Max./Min. code length:** Refer to [Max./Min. code length](#) of [3-14 Code 39 \(Code 32, Trioptic Code 39\)](#).

**Code id setting:** Refer to [Code ID setting](#) of [3-9 UPC-A](#).

**Insertion group selection:** Refer to [Insertion group selection](#) of [3-9 UPC-A](#).

**Truncate leading zeros:** The leading "0" digits of Code 128 barcode characters can be truncated when the feature is enabled.

Multiple-scan setting				Single-scan setting
Option barcode	Para. code	Option	Para. value	
Read  %2001M%	0x07 0xD1	Disable	00	 %2001D00%
		Enable	01*	 %2001D01% *
Check digit verification  %2002M%	0x07 0xD2	Disable	00	 %2002D00%
		Enable	01*	 %2002D01% *
Check digit trans.  %2003M%	0x07 0xD3	Disable	00*	 %2003D00% *
		Enable	01	 %2003D01%
Max. code length  %2004M%	0x07 0xD4	00-99	00-99	
			99*	 %2004D99% *
Min. code length  %2005M%	0x07 0xD5	00-99	00-99	
			01*	 %2005D01% *
Code ID setting  %2006M%	0x07 0xD6	00-FF <sub>16</sub> (ASCII)	00-FF <sub>16</sub>	
			<K>*	 %2006H4B% *
Insert group selection  %2007M%	0x07 0xD7	00-66	00-66	
			00*	 %2007D00% *
Truncate leading zeros  %2008M%	0x07 0xD8	Disable	00*	 %2008D00% *
		All leading "0"s	01	 %2008D01%
		Only the first "0"	02	 %2008D02%

  
%END%

### 3-20 UCC/EAN 128 (GS1-128)

**Read:**

Format

Data digits (variable)	Check digit (optional)
------------------------	------------------------

**Check digit verification:** The check digit is made as the sum module 103 of all data digits.

**Check digit trans.:** By setting Enable, check digit will be transmitted.

**Max./Min. code length:** Refer to 

Max./Min. code length
-----------------------

 of [3-14 Code 39 \(Code 32, Trioptic Code 39\)](#).

**Code id setting:** Refer to 

Code ID setting
-----------------

 of [3-9 UPC-A](#).

**Insertion group selection:** Refer to 

Insertion group selection
---------------------------

 of [3-9 UPC-A](#).

**Truncate leading zeros:** Refer to 

Truncate leading zeros
------------------------

 of [3-19 Code 128](#).



Multiple-scan setting				Single-scan setting
Option barcode	Para. code	Option	Para. value	
Read  %2501M%	0x09 0xC5	Disable	00	 %2501D00%
		Enable	01*	 %2501D01% *
Check digit verification  %2502M%	0x09 0xC6	Disable	00	 %2502D00%
		Enable	01*	 %2502D01% *
Check digit trans.  %2503M%	0x09 0xC7	Disable	00*	 %2503D00% *
		Enable	01	 %2503D01%
Max. code length  %2504M%	0x09 0xC8	00-99	00-99	
			99*	 %2504D99% *
Min. code length  %2505M%	0x09 0xC9	00-99	00-99	
			01*	 %2505D01% *
Code ID setting  %2506M%	0x09 0xCA	00-FF <sub>16</sub> (ASCII)	00-FF <sub>16</sub>	
			<K>*	 %2506H4B% *
Insert group selection  %2507M%	0x09 0xCB	00-66	00-66	
			00*	 %2507D00% *
Truncate leading zeros  %2508M%	0x09 0xCC	Disable	00*	 %2508D00% *
		All leading "0"s	01	 %2508D01%
		Only the first "0"	02	 %2508D02%

  
%END%

### 3-21 ISBT 128

**Read:**

Format

Data digits (variable)	Check digit (optional)
------------------------	------------------------

**Check digit verification:** The check digit is made as the sum module 103 of all data digits.

**Check digit trans.:** By setting Enable, check digit will be transmitted.

**Max./Min. code length:** Refer to 

Max./Min. code length
-----------------------

 of [3-14 Code 39 \(Code 32, Trioptic Code 39\)](#).

**Code id setting:** Refer to 











Code ID setting
-----------------

 of [3-9 UPC-A](#).

**Insertion group selection:** Refer to 

Insertion group selection
---------------------------

 of [3-9 UPC-A](#).

Multiple-scan setting				Single-scan setting
Option barcode	Para. code	Option	Para. value	
Read  %3301M%	0x0C 0xE5	Disable	00	 %3301D00%
		Enable	01*	 %3301D01% *
Check digit verification  %3302M%	0x0C 0xE6	Disable	00	 %3302D00%
		Enable	01*	 %3302D01% *
Check digit trans.  %3303M%	0x0C 0xE7	Disable	00*	 %3303D00% *
		Enable	01	 %3303D01%
Max. code length  %3304M%	0x0C 0xE8	00-99	00-99	
			99*	 %3304D99% *
Min. code length  %3305M%	0x0C 0xE9	00-99	00-99	
			01*	 %3305D01% *
Code ID setting  %3306M%	0x0C 0xEA	00-FF <sub>16</sub> (ASCII)	00-FF <sub>16</sub>	
			<K>*	 %3306H4B% *
Insert group selection  %3307M%	0x0C 0xEB	00-66	00-66	
			00*	 %3307D00% *

  
 %END%

### 3-22 Code 93

**Read:**

Format

Data digits (variable)	2 Check digit (optional)
------------------------	--------------------------

**Check digit verification:** The check digit is made as the sum module 47 of all data digits.

**Check digit trans.:** By setting Enable, check digit will be transmitted.

**Max./Min. code length:** Refer to 

Max./Min. code length
-----------------------

 of [3-14 Code 39 \(Code 32, Trioptic Code 39\)](#).

**Code id setting:** Refer to 















Code ID setting
-----------------

 of [3-9 UPC-A](#).

**Insertion group selection:** Refer to 

Insertion group selection
---------------------------

 of [3-9 UPC-A](#).

Multiple-scan setting				Single-scan setting
Option barcode	Para. code	Option	Para. value	
Read  %2101M%	0x08 0x35	Disable	00	 %2101D00%
		Enable	01*	 %2101D01% *
Check digit verification  %2102M%	0x08 0x36	Disable	00	 %2102D00%
		Enable	01*	 %2102D01% *
Check digit trans.  %2103M%	0x08 0x37	Disable	00*	 %2103D00% *
		Enable	01	 %2103D01%
Max. code length  %2104M%	0x08 0x38	00-99	00-99	
			99*	 %2104D99% *
Min. code length  %2105M%	0x08 0x39	00-99	00-99	
			01*	 %2105D01% *
Code ID setting  %2106M%	0x08 0x3A	00-FF <sub>16</sub> (ASCII)	00-FF <sub>16</sub>	
			<L>*	 %2106H4C% *
Insert group selection  %2107M%	0x08 0x3B	00-66	00-66	
			00*	 %2107D00% *

  
 %END%

### 3-23 Code 11

**Read:**

Format

Data digits (variable)	Check digit 1 (optional)	Check digit 2 (optional)
------------------------	--------------------------	--------------------------

**Check digit verification:** The check digit is made as the sum module 11 of all data digits.

**Check digit trans.:** By setting Enable, check digit will be transmitted.

**Max./Min. code length:** Refer to 

Max./Min. code length
-----------------------

 of [3-14 Code 39 \(Code 32, Trioptic Code 39\)](#).

**Code id setting:** Refer to 



Code ID setting
-----------------

 of [3-9 UPC-A](#).

**Insertion group selection:** Refer to 

Insertion group selection
---------------------------

 of [3-9 UPC-A](#).

Multiple-scan setting				Single-scan setting
Option barcode	Para. code	Option	Para. value	
Read  %2201M%	0x08 0x99	Disable	00*	 %2201D00% *
		Enable	01	 %2201D01%
Check digit verification  %2202M%	0x08 0x9A	Disable	00	 %2202D00%
		1 digit	01*	 %2202D01% *
Check digit trans.  %2203M%	0x08 0x9B	Disable	00*	 %2203D00% *
		Enable	01	 %2203D01%
Max. code length  %2204M%	0x08 0x9C	00-99	00-99	
			99*	 %2204D99% *
Min. code length  %2205M%	0x08 0x9D	00-99	00-99	
			04*	 %2205D04% *
Code ID setting  %2206M%	0x08 0x9E	00-FF <sub>16</sub> (ASCII)	00-FF <sub>16</sub>	
			<V>*	 %2206H56% *
Insert group selection  %2207M%	0x08 0x9F	00-66	00-66	
			00*	 %2207D00% *

  
 %END%

### 3-24 MSI/Plessey

**Read:**

Format

Data digits (variable)	Check digit 1 (optional)	Check digit 2 (optional)
------------------------	--------------------------	--------------------------

**Check digit verification:** The MSI/Plessey has one or two optional check digits. There are three methods of verifying check digits, i.e. Mod10, Mod10/10 Mod11/10. The check digit1 and check digit 2 will be calculated as the sum module 10 or 11 of the data digits.

**Check digit trans.:** By setting Enable, check digit will be transmitted.

**Max./Min. code length:** Refer to 

Max./Min. code length
-----------------------

 of [3-14 Code 39 \(Code 32, Trioptic Code 39\)](#).

**Code id setting:** Refer to 

Code ID setting
-----------------

 of [3-9 UPC-A](#).

**Insertion group selection:** Refer to 

Insertion group selection
---------------------------

 of [3-9 UPC-A](#).



Multiple-scan setting				Single-scan setting
Option barcode	Para. code	Option	Para. value	
Read  %2301M%	0x08 0xFD	Disable	00*	 %2301D00% *
		Enable	01	 %2301D01%
Check digit verification  %2302M%	0x08 0xFE	Disable	00*	 %2302D00% *
		1 digit (Mod 10)	01	 %2302D01%
		2 digits (Mod 10/10)	02	 %2302D02%
		2 digits (Mod 10/11)	03	 %2302D03%
Check digit trans.  %2303M%	0x08 0xFF	Disable	00*	 %2303D00% *
		Enable	01	 %2303D01%
Max. code length  %2304M%	0x09 0x00	00-99	00-99	
			99*	 %2304D99% *
Min. code length  %2305M%	0x09 0x01	00-99	00-99	
			04*	 %2305D04% *
Code ID setting  %2306M%	0x09 0x02	00-FF <sub>16</sub> (ASCII)	00-FF <sub>16</sub>	
			<O>*	 %2306H4F% *
Insert group selection  %2307M%	0x09 0x03	00-66	00-66	
			00*	 %2307D00% *
 %END%				

### 3-25 UK/Plessey

**Read:**

Format

Data digits (variable)	2 Check digits (optional)
------------------------	---------------------------

**Check digit verification:** The UK/Plessey has one or two optional check digits. The check digit 1 and check digit 2 will be calculated as the sum module 10 or 11 of the data digits.

**Check digit trans.:** By setting Enable, check digit will be transmitted.

**Max./Min. code length:** Refer to 

Max./Min. code length
-----------------------

 of [3-14 Code 39 \(Code 32, Trioptic Code 39\)](#).

**Code id setting:** Refer to 

















Code ID setting
-----------------

 of [3-9 UPC-A](#).

**Insertion group selection:** Refer to 

Insertion group selection
---------------------------

 of [3-9 UPC-A](#).

Multiple-scan setting				Single-scan setting
Option barcode	Para. code	Option	Para. value	
Read  %2401M%	0x09 0x61	Disable	00*	 %2401D00% *
		Enable	01	 %2401D01%
Check digit verification  %2402M%	0x09 0x62	Disable	00	 %2402D00%
		Enable	01*	 %2402D01% *
Check digit trans.  %2403M%	0x09 0x63	Disable	00*	 %2403D00% *
		Enable	01	 %2403D01%
Max. code length  %2404M%	0x09 0x64	00-99	00-99	
			99*	 %2404D99% *
Min. code length  %2405M%	0x09 0x65	00-99	00-99	
			01*	 %2405D01% *
Code ID setting  %2406M%	0x09 0x66	00-FF <sub>16</sub> (ASCII)	00-FF <sub>16</sub>	
			<U>*	 %2406H55% *
Insert group selection  %2407M%	0x09 0x67	00-66	00-66	
			00*	 %2407D00% *

  
 %END%

### 3-26 China Post

Read:

Format

11 Data digits

Max./Min. code length: Refer to Max./Min. code length of [3-14 Code 39 \(Code 32, Trioptic Code 39\)](#).

Code id setting: Refer to Code ID setting of [3-9 UPC-A](#).

Insertion group selection: Refer to Insertion group selection of [3-9 UPC-A](#).

Multiple-scan setting				Single-scan setting
Option barcode	Para. code	Option	Para. value	
Read  %2601M%	0x0A 0x29	Disable	00	 %2601D00%
		Enable	01*	 %2601D01% *
Max. code length  %2604M%	0x0A 0x2C	00-99	00-99	
			11*	 %2604D11% *
Min. code length  %2605M%	0x0A 0x2D	00-99	00-99	
			11*	 %2605D11% *
Code ID setting  %2606M%	0x0A 0x2E	00-FF <sub>16</sub> (ASCII)	00-FF <sub>16</sub>	
			<T>*	 %2606H54% *
Insert group selection  %2607M%	0x0A 0x2F	00-66	00-66	
			00*	 %2607D00% *
 %END%				

### 3-27 China Finance

Note: this type of barcode is not Omni-Directionally decodable. The encodable character set includes numeric 0 to 9. Among the symbol of 0 to 9, 0 to 2, 4 and 9, 5 and 8, 6 and 7, have the symmetrical pattern; the pattern of 1 and 3 is symmetrical.

**Read:**

Format

10 Data digits

**Max./Min. code length:** Refer to Max./Min. code length of [3-14 Code 39 \(Code 32, Trioptic Code 39\)](#).

**Check digit verification:** The check digit is calculated as the sum module 10 of the data digits.



















**Leading character 5/6/7/8/9 converted to A/B/C/D/E:** By setting, leading character 5/6/7/8/9 can be converted to A/B/C/D/E.

**Leading character assignment:** By setting, only barcode with the assigned leading character can be output.

**Code id setting:** Refer to Code ID setting of [3-9 UPC-A](#).

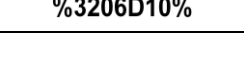
**Insertion group selection:** Refer to Insertion group selection of [3-9 UPC-A](#).

Multiple-scan setting				Single-scan setting
Option barcode	Para. code	Option	Para. value	
Read  %3201M%	0x0C 0x81	Disable	00	 %3201D00%
		Enable	01*	 %3201D01% *
Max. code length  %3202M%	0x0C 0x82	00-99	00-99	
			10*	 %3202D10% *
Min. code length  %3203M%	0x0C 0x83	00-99	00-99	
			10*	 %3203D10% *
Check digit verification  %3204M%	0x0C 0x84	Disable	00*	 %3204D00% *
		Reserved	01	 %3204D01%
Leading character 5/6/7/8/9 converted to A/B/C/D/E  %3205M%	0x0C 0x85	Disable	00	 %3205D00%
		Enable	01*	 %3205D01% *
		Only 5 converted to A	02	 %3205D02%

Multiple-scan setting				Single-scan setting
Option barcode	Para. code	Option	Para. value	
		Only 6 converted to B	03	 %3205D03%
		Only 7 converted to C	04	 %3205D04%
		Only 8 converted to D	05	 %3205D05%
		Only 9 converted to E	06	 %3205D06%
Leading character assignment  %3206M%	0x0C 0x86	Disable	00	 %3206D00%
		Assigned to 0	01*	 %3206D01% *
		Assigned to 5 (A)	02	 %3206D02%
		Assigned to 6 (B)	03	 %3206D03%
		Assigned to 7 (C)	04	 %3206D04%
		Assigned to 8 (D)	05	 %3206D05%
		Assigned to 9 (E)	06	 %3206D06%
		Assigned to 1	07	 %3206D07%
		Assigned to 2	08	 %3206D08%
		Assigned to 3	09	 %3206D09%
		Assigned to 4	10	 %3206D10%
Code ID setting  %3207M%	0x0C 0x87	00-FF <sub>16</sub> (ASCII)	00-FF <sub>16</sub>	
			<Y>*	 %3207H59% *
Insert group selection  %3208M%	0x0C 0x88	00-66	00-66	
			00*	 %3208D00% *

  
%END%

### 3-28 GS1 DataBar (GS1 DataBar Truncated)

GS1 DataBar Truncated is structured and encoded the same as the GS1 DataBar except that its height is reduced to a 13 modules minimum; while GS1 DataBar should have a height greater than or equal to 33 modules.

**Read:**

Format

16 Data digits

**Code id setting:** Refer to Code ID setting of 3-9 UPC-A.

**Insertion group selection:** Refer to Insertion group selection of 3-9 UPC-A.

**Conversion**

**UCC/EAN 128** - Refer to Code ID transmission of 3-41 String transmission, ]Cm will be identified as AIM ID.

**UPC-A or EAN-13** - Barcode beginning with a single zero as the first digit has the leading “010” stripped and the barcode reported as EAN-13. Barcode beginning with two or more zeros but not six zeros has the leading “0100” stripped and the barcode reported as UPC-A.

Multiple-scan setting				Single-scan setting
Option barcode	Para. code	Option	Para. value	
Read  %2701M%	0x0A 0x8D	Disable	00	 %2701D00%
		Enable	01*	 %2701D01% *
Code ID setting  %2702M%	0x0A 0x8E	00-FF <sub>16</sub> (ASCII)	00-FF <sub>16</sub>	
			<R>*	 %2702H52% *
Insert group selection  %2703M%	0x0A 0x8F	00-66	00-66	
			00*	 %2703D00% *
Conversion  %2704M%	0x0A 0x90	None	00*	 %2704D00% *
		UCC/EAN 128	01	 %2704D01%
		UPC-A or EAN-13	02	 %2704D02%

  
%END%

### 3-29 GS1 DataBar Limited

Read:









Format

16 Data digits

Code id setting: Refer to Code ID setting of 3-9 UPC-A.

Insertion group selection: Refer to Insertion group selection of 3-9 UPC-A.

Conversion: Refer to Conversion of 3-28 GS1 DataBar (GS1 DataBar Truncated).

Multiple-scan setting				Single-scan setting
Option barcode	Para. code	Option	Para. value	
Read  %2801M%	0x0A 0xF1	Disable	00	 %2801D00%
		Enable	01*	 %2801D01% *
Code ID setting  %2802M%	0x0A 0xF2	00-FF <sub>16</sub> (ASCII)	00-FF <sub>16</sub>	
			<R>*	 %2802H52% *
Insert group selection  %2803M%	0x0A 0xF3	00-66	00-66	
			00*	 %2803D00% *
Conversion  %2804M%	0x0A 0xF4	None	00*	 %2804D00% *
		UCC/EAN 128	01	 %2804D01%
		UPC-A or EAN-13	02	 %2804D02%
 %END%				



### 3-30 GS1 DataBar Expanded

Read:

Format

Data digits (variable)

Code id setting: Refer to Code ID setting of 3-9 UPC-A.

Insertion group selection: Refer to Insertion group selection of 3-9 UPC-A.

Conversion: Refer to Conversion of 3-28 GS1 DataBar (GS1 DataBar Truncated).

Multiple-scan setting				Single-scan setting
Option barcode	Para. code	Option	Para. value	
Read  %2901M%	0x0B 0x55	Disable	00	 %2901D00%
		Enable	01*	 %2901D01% *
Max. code length  %2902M%	0x0B 0x56	00-99	00-99	
			99*	 %2902D99% *
Min. code length  %2903M%	0x0B 0x57	00-99	00-99	
			01*	 %2903D01% *
Code ID setting  %2904M%	0x0B 0x58	00-FF <sub>16</sub> (ASCII)	00-FF <sub>16</sub>	
			<R>*	 %2904H52% *
Insert group selection  %2905M%	0x0B 0x59	00-66	00-66	
			00*	 %2905D00% *
Conversion  %2906M%	0x0B 0x5A	None	00*	 %2906D00% *
		UCC/EAN 128	01	 %2906D01%

  
 %END%

### 3-31 GS1 Composite

GS1 Composite symbol group consists of two components: a linear component, which encodes the item's primary data; and an adjacent 2D composite component, which contains supplementary data. The linear component will be a traditional symbol of types: GS-128, EAN-8, EAN-13, UPC-A, UPC-E or DataBar.

The composite component will be either a CC-A (encoding up to 56 digits), a CC-B (up to 338 digits) or a CC-C (up to 2361 digits).

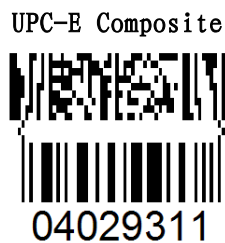
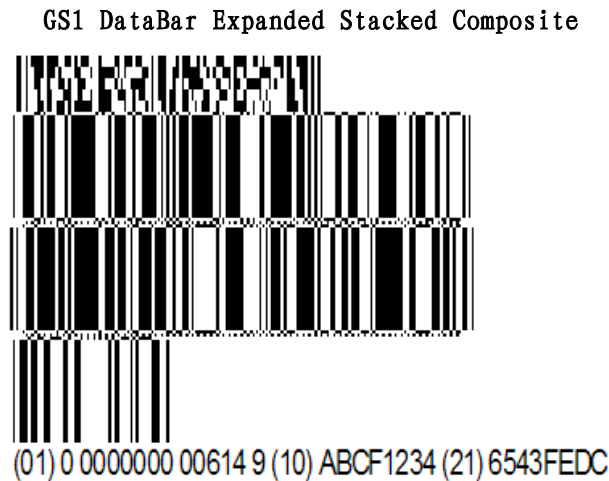





#### GS1 composite version enabled:

- ✓ **Note 1-** While this feature is enabled, the decode speed will be dropped. The more versions are enabled, the more obvious influence.
- ✓ **Note 2-** If the corresponding linear 1D barcode symbol is set disable, only 2D composite data will be output after a success decode.
- ✓ **Note 3-** While this feature is set disable, if the corresponding linear 1D barcode symbol is set enable, only 1D data will be output after a success decode.
- ✓ **Note 4-** For UPC/EAN Composite, if 2D composite component is failed to decode and 1D linear component is successful to decode, then only 1D data will be output.
- ✓ **Note 5-** If both GS-128 and DataBar Composite are set Enable, both 1D and 2D components must be successfully decoded to output both 1D and 2D data.

**GS1-128 Composite, DataBar Composite** - Two versions of GS1 Composite symbol are enabled.

**GS1-128 Composite, DataBar Composite, UPC/EAN Composite** - Three versions of GS1 Composite symbol are enabled.







Multiple-scan setting				Single-scan setting
Option barcode	Para. code	Option	Para. value	
GS1 composite version enabled  %3501M%	0x0D 0xAD	None (Disable)	00*	 %3501D00% *
		GS1-128 Composite, DataBar Composite	01	 %3501D01%
		GS1-128 Composite, DataBar Composite, UPC/EAN Composite	02	 %3501D02%
 %END%				

### 3-32 PDF417

Read:

Format

Data digits (variable)







Multiple-scan setting				Single-scan setting
Option barcode	Para. code	Option	Para. value	
Read  %3001M%	0x0B 0xB9	Disable	00	 %3001D00%
		Enable	01*	 %3001D01% *
Code ID setting  %3002M%	0x0B 0xBA	00-FF <sub>16</sub> ( ASCII )	00-FF <sub>16</sub>	
			<p>*	 %3002H70% *
 %END%				

### 3-33 MicroPDF417

Read:

Format

Data digits (variable)







Multiple-scan setting				Single-scan setting
Option barcode	Para. code	Option	Para. value	
Read  %3101M%	0x0C 0x1D	Disable	00*	 %3101D00% *
		Enable	01	 %3101D01%
Code ID setting  %3102M%	0x0C 0x1E	00-FF <sub>16</sub> ( ASCII )	00-FF <sub>16</sub>	
			<p>*	 %3102H70% *
 %END%				

### 3-34 QR Code

Read:

Format

Data digits (variable)







Multiple-scan setting				Single-scan setting
Option barcode	Para. code	Option	Para. value	
Read  %4001M%	0x0F 0xA1	Disable	00	 %4001D00%
		Enable	01*	 %4001D01% *
Code ID setting  %4002M%	0x0F 0xA2	00-FF <sub>16</sub> ( ASCII )	00-FF <sub>16</sub>	
			<q>*	 %4002H71% *
 %END%				

# 3-35 Micro QR

Read:

Format

Data digits (variable)







Multiple-scan setting				Single-scan setting
Option barcode	Para. code	Option	Para. value	
Read  %4501M%	0x11 0x95	Disable	00*	 %4501D00% *
		Enable	01	 %4501D01%
Code ID setting  %4502M%	0x11 0x96	00-FF <sub>16</sub> ( ASCII )	00-FF <sub>16</sub>	
			<q>*	 %4502H71% *
 %END%				

### 3-36 Data Matrix

Read:

Format

Data digits (variable)

Multiple-scan setting				Single-scan setting
Option barcode	Para. code	Option	Para. value	
Read  %4101M%	0x10 0x05	Disable	00	 %4101D00%
		Enable	01*	 %4101D01% *
Code ID setting  %4102M%	0x10 0x06	00-FF <sub>16</sub> ( ASCII )	00-FF <sub>16</sub>	
			<d>*	 %4102H64% *
 %END%				









### 3-37 Han Xin Code

Read:

Format

Data digits (variable)







Multiple-scan setting				Single-scan setting
Option barcode	Para. code	Option	Para. value	
Read  %4201M%	0x10 0x69	Disable	00*	 %4201D00% *
		Enable	01	 %4201D01%
Code ID setting  %4202M%	0x10 0x6A	00-FF <sub>16</sub> ( ASCII )	00-FF <sub>16</sub>	
			<h>*	 %4202H68% *
 %END%				

### 3-38 Aztec Code

Read:

Format

Data digits (variable)

Multiple-scan setting				Single-scan setting
Option barcode	Para. code	Option	Para. value	
Read  %4301M%	0x10 0xCD	Disable	00*	 %4301D00% *
		Enable	01	 %4301D01%
Code ID setting  %4302M%	0x10 0xCE	00-FF <sub>16</sub> ( ASCII )	00-FF <sub>16</sub>	
			<a>*	 %4302H61% *
 %END%				

### 3-39 G1-G6 & C1-C2 & FN1 substitution string setting

**Format of barcode data transmission:**

Prefix	Code name	Preamble	Code ID	Code length	Code data	Code ID	Postamble	Suffix
--------	-----------	----------	---------	-------------	-----------	---------	-----------	--------

**Suffix string setting:** The <enter> key is represented indifferent ASCII when it is applied by different OS. For a Windows/DOS OS, <enter> is represented as <CR><LF> (0x0D 0x0A); for an Apple MAC OS, <enter> is represented as <CR> (0x0D); for a Linux/Unix OS, <enter> is represented as <LF> (0x0A).

**Prefix/Suffix/Preamble/Postamble string setting:** They are appended to the data automatically when a barcode is decoded.

Example: Add a symbol of “\$” as a prefix for all symbols.

Steps:

- 1) Scan the option barcode of Prefix string setting.
- 2) Use the ASCII table to find the value of \$ → 24.
- 3) Scan 2 and 4.
- 4) Scan %END% barcode.

Scanning steps: Scan the following barcodes in order.



or



%8001H24%8201D01%

**Insert G1/G2/G3/G4 string setting:** The engine offers 4 positions and 4 character strings to insert among a symbol.

Example: Set G1 string to be “AB”.

Original code data	“1 2 3 4 5 6”
Output code data	“1 2 A B 3 4 5 6”

Steps:

- 1) Scan the option barcode of Insert G1 string setting.
- 2) Use the ASCII table to find the value of A →41, B→42
- 3) Scan 4, 1 and 4, 2.
- 4) Scan %END% barcode.
- 5) Refer to [3-39 G1-G4 string position & Code ID position](#).
- 6) Refer to [3-5 Scan mode & some global settings](#).



Testing barcode:



**FN1 substitution string setting:** The FN1 character (0x1D) in an UCC/EAN128 barcode, or a Code 128 barcode, or a GS1 DataBar barcode can be substituted with a defined string.

**Truncate leading G5 string setting:** By setting, a defined leading character or string can be truncated. Also a single character can be un-defined.

**Repeat of a G5 character setting:** While G5 is set as a single defined or un-defined character, G5 can also be set to be repeated. This setting is ignored when the truncated number is more than the barcode data characters. The option of "FF" for this setting is not active while the option of **Truncate leading G5 string setting** is "00".

Example: Truncate all leading zeros for all symbols.

Original code data	"0 0 0 1 2 3 4 5 6"
Output code data	"1 2 3 4 5 6"

Steps: scan the following data in order.



Testing barcode:



**Truncate ending G6 string setting:** By setting, a defined ending character or sting can be truncated. Also a single character can be undefined.

**Repeat of a G6 character setting:** While G6 is set as a single defined or undefined character, G7 can also be set to be repeated. This setting is ignored when the truncated number is more than the barcode data characters. The option of "FF" for this setting is not active while the option of **Truncated ending G6 string setting** is "00".

**Single character C1/C2 replacement:** By setting, a defined character in the data string can be replaced

by another defined character. The C1 and C2 replacement are applied simultaneously.

Example: Replace all the “A” character in a data string to be “B” character.

Original code data	“1 2 3 A 5 A”
Output code data	“1 2 3 B 5 B”

Steps: scan the following barcodes in order. The ASCII value for “A” is 41, and the ASCII value for “B” is 42.





or



Testing barcode:

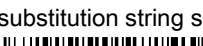
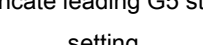

Multiple-scan setting				Single-scan setting
Option barcode	Para. code	Option	Para. value	
Prefix string setting  %8001M%	0x1F 0x41	0-22 characters	00-FF <sub>16</sub>	 %8001H00% *
		None	00*	
Suffix string setting  %8002M%	0x1F 0x42	0-22 characters	00-FF <sub>16</sub>	
		<ENTER>	0D0A*	
Preamble string setting  %8003M%	0x1F 0x43	0-22 characters	00-FF <sub>16</sub>	 %8003H00% *
		none	00*	
Postamble string setting  %8004M%	0x1F 0x44	0-22 characters	00-FF <sub>16</sub>	 %8004H00% *
		none	00*	
Insert G1 string setting  %8005M%	0x1F 0x45	0-22 characters	00-FF <sub>16</sub>	 %8005H00% *
		none	00*	
Insert G2 string setting  %8006M%	0x1F 0x46	0-22 characters	00-FF <sub>16</sub>	 %8006H00% *
		none	00*	
Insert G3 string setting  %8007M%	0x1F 0x47	0-22 characters	00-FF <sub>16</sub>	 %8007H00% *
		none	00*	
Insert G4 string setting  %8008M%	0x1F 0x48	0-22 characters	00-FF <sub>16</sub>	 %8008H00% *
		none	00*	
FN1 substitution string setting  %8009M%	0x1F 0x49	0-4 characters	00-FF <sub>16</sub>	 %8009H20% *
		<SP>	20*	
Truncate leading G5 string setting  %8010M%	0x1F 0x4A	A un-defined character	00	 %8010H00%
		1-22 defined characters	01-7F <sub>16</sub>	

Multiple-scan setting				Single-scan setting
Option barcode	Para. code	Option	Para. value	
		<0>	30*	%8010H30% *
Repeat of a G5 character setting %8011M%	0x1F 0x4B	Defined times	01-22	
		Un-defined times (All)	FF	%8011HFF%
		Once	01*	%8011H01% *
Truncate ending G6 string setting %8012M%	0x1F 0x4C	1-22 defined characters	01-7F <sub>16</sub>	
		A un-defined character	00	%8012H00%
		<0>	30*	%8012H30% *
Repeat of a G6 character setting %8013M%	0x1F 0x4D	Defined times	01-22	
		Un-defined times (All)	FF	%8013HFF%
		Once	01*	%8013H01% *
Single character C1 replacement %8014M%	0x1F 0x4E	<0000>	0000*	
			0000-FFFF <sub>16</sub>	
Single character C2 replacement %8015M%	0x1F 0x4F	<0000>	0000*	
			0000-FFFF <sub>16</sub>	
%END%				

### 3-40 G1-G4 string position & Code ID position

#### Format of barcode data transmission

Prefix	Code name	Preamble	Code ID	Code length	Code data	Code ID	Postamble	Suffix
--------	-----------	----------	---------	-------------	-----------	---------	-----------	--------

**Insert G1/G2/G3/G4 string position:** The engine offers 4 positions to insert strings among the symbol. In case of the insertion position is greater than the length of the symbol, the insertion of string is not affected.

**Code ID position:** It is allowed to select different positions of code ID placement.

Multiple-scan setting				Single-scan setting
Option barcode	Para. code	Option	Para. value	
Insert G1 string position  %8101M%	0x1F 0xA5	00-99	00-99	 %8101D00% *
			00*	
Insert G2 string position  %8102M%	0x1F 0xA6	00-99	00-99	 %8102D00% *
			00*	
Insert G3 string position  %8103M%	0x1F 0xA7	00-99	00-99	 %8103D00% *
			00*	
Insert G4 string position  %8104M%	0x1F 0xA8	00-99	00-99	 %8104D00% *
			00*	
Code ID position  %8105M%	0x1F 0xA9	Before code data	00*	 %8105D00% *
		After code data	01	 %8105D01%
 %END%				



### 3-41 String transmission

#### Format of barcode data transmission

Prefix	Code name	Preamble	Code ID	Code length	Code data	Code ID	Postamble	Suffix
--------	-----------	----------	---------	-------------	-----------	---------	-----------	--------

**Prefix transmission:** By setting Enable, prefix will be appended before the data transmitted.

**Suffix transmission:** By setting Enable, suffix will be appended before the data transmitted.

**Code name transmission:** By setting Enable, code name will be transmitted before code data.

**Preamble transmission:** By setting Enable, preamble will be appended before the data transmission

**Postamble transmission:** By setting Enable, Postamble will be appended after the data transmission.

**Code ID transmission:** By setting Enable, Code ID can be transmitted in the format of either Proprietary ID or AIM ID. Refer to [1-2 Default setting for each barcode](#).

**Code length transmission:** The length of code data string can be transmitted before the code data transmitted when Enable is selected. The length is represented by a number with two digits.

**Case conversion:** The characters within code data or the whole output string can be set in either upper case or lower case.







**FN1 substitution transmission:** The engine supports a FN1 substitution feature. The replacement string of FN1 can be chosen by user (see [3-39 G1-G6 & C1-C2 & FN1 substitution string setting](#)).

**All-non-printable-character string transmission with string setting:** By setting Enable, all string settings, e.g. Preamble transmission or Insert G1 string setting, are active for an all-non-printable-character string. Here a non-printable character means a character with ASCII value between 0x00 to 0x1F.

**Transmit the first N data characters only:** The engine supports to only transmit the first N data characters of a barcode. The number of N can be set as a digit between 1 and 99.

**Transmit the last N data characters only:** The engine supports to only transmit the last N data characters of a barcode. The number of N can be set as a digit between 1 and 99.

Multiple-scan setting				Single-scan setting
Option barcode	Para. code	Option	Para. value	
Prefix transmission  %8201M%	0x20 0x09	Disable	00*	 %8201D00% *
		Enable	01	 %8201D01%
Suffix transmission  %8202M%	0x20 0x0A	Disable	00*	 %8202D00% *
		Enable	01	 %8202D01%
Code name transmission  %8203M%	0x20 0x0B	Disable	00*	 %8203D00% *
		Enable	01	 %8203D01%
Preamble transmission  %8204M%	0x20 0x0C	Disable	00*	 %8204D00% *
		Enable	01	 %8204D01%
Postamble transmission  %8205M%	0x20 0x0D	Disable	00*	 %8205D00% *
		Enable	01	 %8205D01%
Code ID transmission  %8206M%	0x20 0x0E	Disable	00*	 %8206D00% *
		Enable	01	 %8206D01%
Code length transmission  %8207M%	0x20 0x0F	Disable	00*	 %8207D00% *
		Enable	01	 %8207D01%
Case conversion  %8208M%	0x20 0x10	Disable	00*	 %8208D00% *
		Enable	01	 %8208D01%
FN1 substitution transmission  %8209M%	0x20 0x11	Disable	00*	 %8209D00% *
		Enable	01	 %8209D01%
All-non-printable-character string transmission with string	0x20 0x12	Disable	00*	 %8210D00% *

Multiple-scan setting				Single-scan setting
Option barcode	Para. code	Option	Para. value	
setting  %8210M%		Enable	01	 %8210D01%
Transmit the first N data characters only  %8211M%	0x20 0x13	01-99		
		All	99*	 %8211D99% *
Transmit the last N data characters only  %8212M%	0x20 0x14	01-99		
		All	99*	 %8212D99% *
 %END%				

## 4 Serial Communication Interface (SCI)

This section describes the system requirements of the Serial Communication Interface (SCI), which provides a communication link between an engine and a host. SCI allows the host to configure the engine.

All communication between the engine and the host occur over the hardware interface lines using the SCI protocol.

The host and the engine exchange messages in packets. A packet is a collection of bytes framed by the proper SCI protocol formatting bytes.

Decode data may be sent as ASCII data (unpacketed), or as part of a larger message (packeted), depending on the engine configuration. Refer to [Decode data packet format](#) of [3-5 Scan mode & some global settings](#).

SCI performs the following functions:

- 1) Maintains a bi-directional communication interface between the host and the engine.
- 2) Allows the host to send commands which can configure the engine.
- 3) Passes decoded data from the engine to the host. The data is in SCI packet format or in ASCII format.

The SCI environment consists of an engine, a serial cable which attaches to a host.

The SCI interface transmits all decode data including special formatting (e.g., AIM ID). The format of this data can be controlled via parameter settings. The engine may also send parameter information, product identification information or event codes to the host.

[5 SCI Transactions](#) describes the required sequence of messages in a number of specific cases.

Table 4-1 lists all the SCI commands supported by the engine. It identifies the SCI partner allowed to send a command of each type.

**Table 4-1 SCI commands**

Name	Opcode	Description
<b>Communication command of host</b>		
BEEP	0xE6	Sound the beeper.
HOST_ACK	0xD0	Positive acknowledgment of received packet from host.
HOST_NAK	0xD1	Negative acknowledgment of received packet from host.
DECODE_DATA	0xF3	Decode data in SCI packet format.
LED_OFF	0xE8	De-activate LED output.
LED_ON	0xE7	Activate LED output.
SCAN_DISABLE	0xEA	Prevent the operator from scanning barcodes.
SCAN_ENABLE	0xE9	Permit barcode scanning.
REQUEST_REVISION	0xA3	Request the engine's configuration.
SLEEP	0xEB	Request to place the engine into low power.
START_DECODE	0xE4	Tell engine to attempt to decode a barcode.
STOP_DECODE	0xE5	Tell engine to abort a decode attempt.
WAKEUP	N/A	Wakeup engine.
PARAM_SEND_HOST	0xD6	Set parameter values.
PARAM_REQUEST	0xD7	Request values of certain parameters.
PARAM_DEFAULTS	0xD8	Set all parameter to factory default values.
CUSTOM_DEFAULTS	0xD9	Set all parameter to custom default values.
REQUEST_REVISION	0xA3	Request revision of engine.
PARAMETER_SCANNING	0xE0	Enable/Disable engine set parameter values by scanning barcode.
NO_READ	0xE1	Enable/Disable engine return 'NR' after a failed decoding.
CAPTURE_IMAGE	0xE2	Host gets the latest image of engine.
<b>Communication command of engine</b>		
ENGINE_ACK	0xD0	Engine sends ACK to host.
ENGINE_NAK	0xD1	Engine sends NAK to host.
DECODE_DATA	0xF3	Decode data in SCI packet format.
PARAM_SEND_ENGINE	0xD7	Engine replies to PARAM_REQUEST of host.
REPLY_REVISION	0xA4	Reply to REQ_REV contains engine's software/ hardware configuration.

## 4-1 Communication command of host

### 4-1-1 BEEP

**Description:** Ask the engine to sound the beeper.

Packet Format

Length	Opcode	Message Source	Status	Beep Code	Checksum
0x05	0xE6	0x04			

Checksum=0x10000-Length-Opcode-Message Source-Status-Beep Code.

Field Descriptions

Field Name	Format	Size	Description
Length	0x05	1 Byte	Length of message (not including checksum).
Opcode	0xE6	1 Byte	Identifies this opcode type.
Message Source	0x04	1 Byte	Message comes from host.
Status	0x00	1 Byte	
Beep Code	See Table 4-2.	1 Byte	Number that identifies a beep sequence.
Checksum		2 Bytes	Checksum of message.

**Table 4-2 Beep code definitions**

Beep Code	Duration (ms)	Pitch	No. of beeps	Beep Code	Duration (ms)	Pitch	No. of beeps
0x00	72	High	1 (Short)	0x0D	1569	High	4 (Long)
0x01	193	High	2 (Short)	0x0E	2011	High	5 (Long)
0x02	315	High	3 (Short)	0x0F	241	Low	1 (Long)
0x03	436	High	4 (Short)	0x10	684	Low	2 (Long)
0x04	558	High	5 (Short)	0x11	1126	Low	3 (Long)
0x05	72	Low	1 (Short)	0x12	1569	Low	4 (Long)
0x06	193	Low	2 (Short)	0x13	2011	Low	5 (Long)
0x07	315	Low	3 (Short)	0x14	382	Hi-Lo-Hi-Lo	4 (Fast Warble)
0x08	436	Low	4 (Short)	0x15	965	Hi-Lo-Hi-Lo	4 (Slow Warble)
0x09	558	Low	5 (Short)	0x16	191	Hi-Lo	2 (Mix 1)
0x0A	241	High	1 (Long)	0x17	191	Lo-Hi	2 (Mix 2)
0x0B	684	High	2 (Long)	0x18	292	Hi-Lo-Hi	3 (Mix 3)
0x0C	1126	High	3 (Long)	0x19	282	Lo-Hi-Lo	3 (Mix 4)

For example:

Length	Opcode	Message Source	Status	Beep Code	Checksum
0x05	0xE6	0x04	0x00	0x06	0xFF 0x0B

The method of calculating Checksum:

Checksum=0x10000-0x05-0xE6-0x04-0x00-0x06=0xFF0B.

Note: When the engine receives this command, it beeps the sequence provided in the BEEP directive. If ACK/NAK handshaking is enabled and a valid beep code is received, the engine replies an ACK.

## 4-1-2 HOST\_ACK

**Description:** Positive acknowledgment of received packet from host.

Packet Format

Length	Opcode	Message Source	Status	Checksum
0x04	0xD0	0x04	0x00	0xFF 0x28

Checksum=0x10000-Length-Opcode-Message Source-Status.

Field Descriptions

Field Name	Format	Size	Description
Length	0x04	1 Byte	Length of message (not including checksum).
Opcode	0xD0	1 Byte	Identifies this Opcode type.
Message Source	0x04	1 Byte	Message comes from host.
Status	0x00	1 Byte	
Checksum	0xFF 0x28	2 Bytes	

### 4-1-3 HOST\_NAK

**Description:** Negative acknowledgment of received packet from host.

Packet Format

Length	Opcode	Message Source	Status	Cause	Checksum
0x05	0xD1	0x04	0x00		

Checksum=0x10000-Length-Opcode-Message Source-Status-Cause.

Field Descriptions

Field Name	Format	Size	Description
Length	0x05	1 Byte	Length of message (not including checksum).
Opcode	0xD1	1 Byte	Identifies this opcode type.
Message Source	0x04	1 Byte	Message comes from host.
Status	0x00	1 Byte	
Cause	Reason code	1 Byte	0x01 = Checksum is incorrect. 0x02 = Host is unable to comply with the requested message (e.g., beep code is out of range). 0x06 = Host does not recognize the command.
Checksum		2 Bytes	Checksum of message.

For example: Host sends NAK to engine. (Checksum incorrect is incorrect)

Length	Opcode	Message Source	Status	Cause	Checksum
0x05	0xD1	0x04	0x00	0x01	0xFF 0x25



#### 4-1-4 LED\_ON

**Description:** Activate LED output.

Packet Format

Length	Opcode	Message Source	Status	LED Selection	Checksum
0x05	0xE7	0x04	0x00	0x01	0xFF 0x0F

Checksum=0x10000-Length-Opcode-Message Source-Status-LED Selection.

Field Descriptions

Field Name	Format	Size	Description
Length	0x05	1 Byte	Length of message (not including checksum).
Opcode	0xE7	1 Byte	Identifies this opcode type.
Message Source	0x04	1 Byte	Message comes from host.
Status	0x00	1 Byte	
LED Selection	0x01	1 Byte	
Checksum	0xFF 0x0F	2 Bytes	Checksum of message.

#### 4-1-5 LED\_OFF

**Description:** De-activate LED output.

Packet Format

Length	Opcode	Message Source	Status	LED Selection	Checksum
0x05	0xE8	0x04	0x00	0x01	0xFF 0x0E

Checksum=0x10000-Length-Opcode-Message Source-Status-LED Selection.

Field Descriptions

Field Name	Format	Size	Description
Length	0x05	1 Byte	Length of message (not including checksum).
Opcode	0xE8	1 Byte	Identifies this opcode type.
Message Source	0x04	1 Byte	Message comes from host.
Status	0x00	1 Byte	
LED Selection	0x01	1 Byte	
Checksum	0xFF 0x0E	2 Bytes	Checksum of message.

#### 4-1-6 START\_DECODE

**Description:** Ask the engine to attempt to decode a barcode.

Packet Format

Length	Opcode	Message Source	Status	Checksum
0x04	0xE4	0x04	0x00	0xFF 0x14

Checksum=0x10000-Length-Opcode-Message Source-Status.

Field Descriptions

Field Name	Format	Size	Description
Length	0x04	1 Byte	Length of message (not including checksum).
Opcode	0xE4	1 Byte	Identifies this opcode type.
Message Source	0x04	1 Byte	Message comes from host.
Status	0x00	1 Byte	
Checksum	0xFF 0x14	2 Bytes	Checksum of message.

Note: The Scan mode (see [3-5 Scan mode & some global settings](#)) must be set to Host.

#### 4-1-7 STOP\_DECODE

**Description:** Ask engine to abort a decode attempt.

Packet Format

Length	Opcode	Message Source	Status	Checksum
0x04	0xE5	0x04	0x00	0xFF 0x13

Checksum=0x10000-Length-Opcode-Message Source-Status.

Field Descriptions

Field Name	Format	Size	Description
Length	0x04	1 Byte	Length of message (not including checksum).
Opcode	0xE5	1 Byte	Identifies this opcode type.
Message Source	0x04	1 Byte	Message comes from host.
Status	0x00	1 Byte	
Checksum	0xFF 0x13	2 Bytes	Checksum of message.

Note: The  (see [3-5 Scan mode & some global settings](#)) must be set to Host.

#### 4-1-8 WAKEUP

**Description:** Wakeup engine after it's been put into Sleep Power state.

**Command format:** Null (0x00)

If the engine is in Sleep Power state, sending the single character Null (0x00) wakes up the engine. This character is only needed when hardware handshaking is not used or is bypassed.

#### **Host Requirements**

Once the WAKEUP command is sent, the host must wait at least 25 ms, but less than 1 second before sending additional data, since the engine is required to wait 1 second after waking up before going back to sleep (if Low Power mode is enabled).

#### **Engine Requirements**

The engine must not return to Sleep Power state for at least 1 second after waking up.

The mechanism to wake up an engine in this manner also works if characters other than WAKEUP are sent to the engine. There is, however, no guarantee that these commands are interpreted correctly upon power-up. Therefore, it is not recommended that characters other than WAKEUP be used to awaken the engine.

The WAKEUP command has no effect if the engine is in AWAKE Power state. If the host is unsure of the engine power state, it can send the WAKEUP command anytime it wants to communicate with the engine, and waits at least 25 ms then sends any command.

## 4-1-9 PARAM\_SEND\_HOST

**Description:** Change particular parameter values.

Note: If you want to save the parameters which is temporary changed, you need to send PARAM\_WRITE\_FLASH command. Refer to [4-1-12 PARAM\\_WRITE\\_FLASH](#).

### Packet Format

Length	Opcode	Message source	Status	Beep code	Para. code	Value. length	Para. value	Checksum
	0XD6	0x04						

Checksum=0x10000-Length-Opcode-Message Source-Status-Beep code-Para. Code-Value length-Para. value.

### Field Descriptions

Field Name	Format	Size	Description
Length		1 Byte	Length of message (not including checksum).
Opcode	0xD6	1 Byte	Identifies this opcode type.
Message Source	0x04	1 Byte	Message comes from host.
Status	0x00 = Temporary change 0x08 = Permanent change	1 Byte	Temporary change, this setting will be lost when power removed. It is not recommended to frequently use.
Beep code	See Table 4-2.	1 Byte	If no beep is required, set this field to 0xFF.
Para. code	<Para_Code_HighByte> <Para_Code_LowByte>	2 Bytes	Each parameter code has two byte.
Value. length		Variable	The counter of the Parameter value.
Para. value		Variable	
Checksum		2 Bytes	

Example 1: to set parameter 0x04 0x4D to 0x00 temporary.

Length	Opcode	Message source	Status	Beep code	Para. code	Value. length	Para. value	Checksum
0x09	0XD6	0x04	0x00	0x01	0x04 0x4D	0x01	0x00	0xFE 0xCA

Example 2: to set parameter 0x04 0x4D to 0x01, 0x04 0xB1 to 0x01 permanent.

Length	Opcode	Message source	Status	Beep code	Para. code	Value length	Para. value	Para. code	Value. length	Para. value	Checksum
0x0D	0XD6	0x04	0x08	0x01	0x04 0x4D	0x01	0x01	0x04 0xB1	0x01	0x01	0xFE 0x06

Example 3: to set parameter 0x1F 0x41 to 0x31, 0x32, 0x33 permanent.

Length	Opcode	Message source	Status	Beep code	Para. code	Value. length	Para. value	Checksum
0x0B	0XD6	0x04	0x08	0x01	0x1F 0x41	0x03	0x31 0x32 0x33	0xFE 0x19

## Engine Requirements

- Due to the processing time of interpreting and storing parameters contained in the message, the engine may not be able to send an ENGINE\_ACK within the programmable **Host Serial Response time-out**. This is not an error; to compensate, increase the time-out.
- When the engine receives a PARAM\_SEND, it interprets and stores the parameters, then ACKs the command (if ACK/NAK handshaking is enabled). Frequent permanent changes are not recommended due to the limited write-cycles of flash memory. If status is set to 0x00, the changes are temporary, and are lost when the engine is powered down.  
If the PARAM\_SEND sent by the host contains a valid beep code (see Table 4-2), the engine issues the requested beep sequence and stores the requested parameter values.

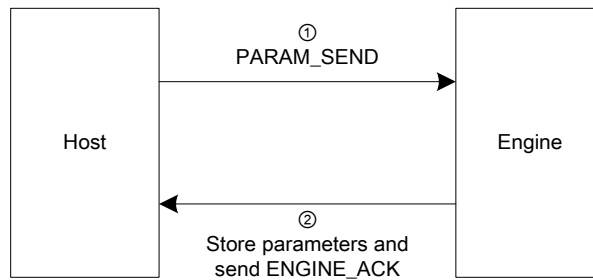

#### 4-1-10 PARAM\_REQUEST

**Description:** Request values of parameters.

**Packet Format:**

Length	Opcode	Message Source	Status	Request Data	Checksum
	0xD7	0x04	0x00		

Checksum=0x10000-Length-Opcode-Message Source-Status-Request Data.

**Field Descriptions:**

Field Name	Format	Size	Description
Length		1 Byte	Length of message (not including checksum).
Opcode	0xD7	1 Byte	Identifies this opcode type.
Message Source	0x04	1 Byte	Message comes from host.
Status	0x00	1 Byte	
Request Data	<Para_code_HighByte><Para_code_LowByte> <Para_code_HighByte><Para_code_LowByte> ...	Variable	Each parameter code has two bytes.
Checksum		2 Bytes	Checksum of message.

**Example 1:**

Host requests parameter 0x04 0x4D.

Length	Opcode	Message Source	Status	Request Data	Checksum
0x06	0xD7	0x04	0x00	0x04 0x4D	0xFE 0xCE

Engine sends value of parameter 0x04 0x4D.

Length	Opcode	Message source	Status	Beep code	Para. code	Value length	Para. value	Checksum
0x00 0x0A	0xD6	0x00	0x00	0xFF	0x04 0x4D	0x01	0x01	0xFF 0xFF 0xFD 0xCE

**Example 2:**

Host requests parameter 0x04 0x4D and parameter 0x04 0xB1.

Length	Opcode	Message Source	Status	Request Data	Request Data	Checksum
0x08	0xD7	0x04	0x00	0x04 0x4D	0x04 0xB1	0xFE 0x17

Engine sends value of parameter 0x04 0x4D and parameter 0x04 0xB1.

Length	Opcode	Message source	Status	Beep code	Para. code	Value length	Para. value	Para. code	Value length	Para. value	Checksum
0x00 0x0E	0xD6	0x00	0x00	0xFF	0x04 0x4D	0x01	0x01	0x04 0xB1	0x01	0x01	0xFF 0xFF 0xFD 0x13



#### 4-1-11 PARAM\_DEFAULTS

**Description:** Set all parameters to factory default values.

Packet Format

Length	Opcode	Message Source	Status	Checksum
0x04	0xD9	0x04	0x00	0xFF 0x1F

Checksum=0x10000-Length-Opcode-Message Source-Status.

Field Descriptions

Field Name	Format	Size	Description
Length	0x04	1 Byte	Length of message (not including checksum).
Opcode	0xD9	1 Byte	Identifies this opcode type.
Message Source	0x04	1 Byte	Message comes from host.
Status	0x00	1 Byte	
Checksum	0xFF 0x1F	2 Bytes	

## 4-1-12 PARAM\_WRITE\_FLASH

**Description:** Write all parameters to flash.

Note: If you want to save the parameters which is temporary changed, you need to send this command to engine.

### Packet Format

Length	Opcode	Message Source	Status	Checksum
0x04	0xEC	0x04	0x00	0xFF 0x0C

Checksum=0x10000-Length-Opcode-Message Source-Status.

### Field Descriptions

Field Name	Format	Size	Description
Length	0x04	1 Byte	Length of message (not including checksum).
Opcode	0xEC	1 Byte	Identifies this opcode type.
Message Source	0x04	1 Byte	Message comes from host.
Status	0x00	1 Byte	
Checksum	0xFF 0x0C	2 Bytes	

#### 4-1-13 CUSTOM\_DEFAULTS

**Description:** Set the parameters to custom default values.

Note: Set all parameters to factory default values except Baud rate, Parity bit, Data bit, Stop bit, Scan mode.

#### Packet Format

Length	Opcode	Message Source	Status	Checksum
0x04	0xD8	0x04	0x00	0xFF 0x20

Checksum=0x10000-Length-Opcode-Message Source-Status.

#### Field Descriptions

Field Name	Format	Size	Description
Length	0x04	1 Byte	Length of message (not including checksum).
Opcode	0xD8	1 Byte	Identifies this opcode type.
Message Source	0x04	1 Byte	Message comes from host.
Status	0x00	1 Byte	
Checksum	0xFF 0x20	2 Bytes	

#### 4-1-14 REQUEST\_REVISION

**Description:** Request the software revision string from the engine.

Packet Format

Length	Opcode	Message Source	Status	Checksum
0x04	0xA3	0x04	0x00	0xFF 0x55

Checksum=0x10000-Length-Opcode-Message Source-Status.

Field Descriptions

Field Name	Format	Size	Description
Length	0x04	1 Byte	Length of message (not including checksum).
Opcode	0xA3	1 Byte	Identifies this opcode type.
Message Source	0x04	1 Byte	
Status	0x00	1 Byte	
Checksum	0xFF 0x55	2 Bytes	

For example: If the HW/SW\_REVISION is "ME5800\_APP\_V1.0.3\_Release/S1.3.4.18/A2.5.8.4", the REPLY\_REVISION message will be:

Length	Opcode	Message Source	Status	Revision	Checksum
0x00 0x36	0xA4	0x00	0x00	0x4D 0x45 0x35 0x38 0x30 0x30 0x5F 0x41 0x50 0x50 0x5F 0x56 0x31 0x2E 0x30 0x2E 0x33 0x5F 0x52 0x65 0x6C 0x65 0x61 0x73 0x65 0x 2F 0x53 0x31 0x2E 0x33 0x2E 0x34 0x2E 0x31 0x38 0x2F 0x41 0x32 0x2E 0x35 0x2E 0x38 0x2E 0x34 0x20 0xAB 0x20 0xF3 0xD7	0xFF 0xFF 0xF1 0x33

Note:

The engine sends its Revision field data string to the host in the following format:

HW/SW\_REVISION<space> ENGINE\_ID<space> REVISION\_CHKSUM

Where:

HW/SW\_REVISION is the version string including hardware and software information.

ENGINE\_ID is always 0xAB.

REVISION\_CHKSUM is a two-byte checksum. It's the 2's complement sum of the Revision contents excluding REVISION\_CHKSUM.

#### 4-1-15 PARAMETER\_SCANNING

Description: Enable/Disable engine set parameter values r by scanning barcode.

Packet Format

Length	Opcode	Message Source	Status	Data	Checksum
0x05	0xE0	0x04	0x00		

Checksum=0x10000-Length-Opcode-Message Source-Status-Data.

Field Descriptions

Field Name	Format	Size	Description
Length	0x05	1 Byte	Length of message (not including checksum).
Opcode	0xE0	1 Byte	Identifies this opcode type.
Message Source	0x04	1 Byte	Message comes from host.
Status	0x00	1 Byte	
Data	0x00=Enable 0x01=Disable	1 Byte	
Checksum		2 Bytes	

Example 1: Host disables set parameters by scanning barcode.

Length	Opcode	Message Source	Status	Data	Checksum
0x05	0xE0	0x04	0x00	0x00	0xFF 0x17

Example 2: Host enables set parameters by scanning barcode.

Length	Opcode	Message Source	Status	Data	Checksum
0x05	0xE0	0x04	0x00	0x01	0xFF 0x16

#### 4-1-16 NO READ

Description: Enable/Disable engine return 'NR' after a failed decoding.

Packet Format

Length	Opcode	Message Source	Status	Data	Checksum
0x05	0xE1	0x04	0x00		

Checksum=0x10000-Length-Opcode-Message Source-Status-Data.

Field Descriptions

Field Name	Format	Size	Description
Length	0x05	1 Byte	Length of message (not including checksum).
Opcode	0xE1	1 Byte	Identifies this opcode type.
Message Source	0x04	1 Byte	Message comes from host.
Status	0x00	1 Byte	
Data	0x00=Enable 0x01=Disable	1 Byte	
Checksum		2 Bytes	

Example 1: Host disables "NR" function.

Length	Opcode	Message Source	Status	Data	Checksum
0x05	0xE1	0x04	0x00	00	0xFF 0x16

Example 2: Host enables "NR" function.

Length	Opcode	Message Source	Status	Data	Checksum
0x05	0xE1	0x04	0x00	01	0xFF 0x15

## 4-1-17 CAPTURE\_IMAGE

**Description:** Host gets the latest image of engine.

Packet Format

Length	Opcode	Message Source	Status	Data	Checksum
0x05	0xE2	0x04	0x00		

Checksum=0x10000-Length-Opcode-Message Source-Status-Data.

Field Descriptions

Field Name	Format	Size	Description
Length	0x05	1 Byte	Length of message (not including checksum).
Opcode	0xE2	1 Byte	Identifies this opcode type.
Message Source	0x04	1 Byte	Message comes from host.
Status	0x00	1 Byte	
Data	0x00 = Raw image 0x01 = Constringent image	1 Byte	
Checksum		2 Bytes	

Example 1: Host gets raw image.

Length	Opcode	Message Source	Status	Data	Checksum
0x05	0xE2	0x04	0x00	00	0xFF 0x15

Example 2: Host gets constringent image.

Length	Opcode	Message Source	Status	Data	Checksum
0x05	0xE2	0x04	0x00	01	0xFF 0x14

#### 4-1-18 SCAN\_ENABLE

**Description:** Permit the engine to scan barcodes.

Packet Format

Length	Opcode	Message Source	Status	Checksum
0x04	0xE9	0x04	0x00	0xFF 0x0F

Checksum=0x10000-Length-Opcode-Message Source-Status.

Field Descriptions

Field Name	Format	Size	Description
Length	0x04	1 Byte	Length of message (not including checksum).
Opcode	0xE9	1 Byte	Identifies this opcode type.
Message Source	0x04	1 Byte	Message comes from host.
Status	0x00	1 Byte	
Checksum	0xFF 0x0F	2 Bytes	



#### 4-1-19 SCAN\_DISABLE

**Description:** Prevent the engine from scanning barcodes.

Packet Format

Length	Opcode	Message Source	Status	Checksum
0x04	0xEA	0x04	0x00	0xFF 0x0E

Checksum=0x10000-Length-Opcode-Message Source-Status.

Field Descriptions

Field Name	Format	Size	Description
Length	0x04	1 Byte	Length of message (not including checksum).
Opcode	0xEA	1 Byte	Identifies this opcode type.
Message Source	0x04	1 Byte	Message comes from host.
Status	0x00	1 Byte	
Checksum	0xFF 0x0E	2 Bytes	

## 4-1-20 SLEEP

**Description:** Request to place the engine into Sleep Power state.

**Packet Format**

Length	Opcode	Message Source	Status	Checksum
0x04	0xEB	0x04	0x00	0xFF 0x0D

Checksum=0x10000-Length-Opcode-Message Source-Status.

**Field Descriptions**

Field Name	Format	Size	Description
Length	0x04	1 Byte	Length of message (not including checksum).
Opcode	0xEB	1 Byte	Identifies this opcode type.
Message Source	0x04	1 Byte	
Status	0x00	1 Byte	
Checksum	0xFF 0x0D	2 Bytes	

## 4-2 Communication command of engine

### 4-2-1 ENGINE\_ACK

**Description:** Positive acknowledgment of received packet from engine.

Packet Format

Length	Opcode	Message Source	Status	Checksum
0x00 0x05	0xD0	0x00	0x00	0xFF 0xFF 0xFF 0x2B

Checksum=0x10000000-Length-Opcode-Message Source-Status.

Field Descriptions

Field Name	Format	Size	Description
Length	0x00 0x05	2 Byte	Length of message (not including checksum).
Opcode	0xD0	1 Byte	Identifies this Opcode type.
Message Source	0x00	1 Byte	Message comes from engine.
Status	0x00	1 Byte	
Checksum	0xFF 0xFF 0xFF 0x2B	4 Bytes	

## 4-2-2 ENGINE\_NAK

**Description:** Negative acknowledgment of received packet from engine.

Packet Format

Length	Opcode	Message Source	Status	Cause	Checksum
0x00 0x06	0xD1	0x00	0x00		

Checksum=0x10000000-Length-Opcode-Message Source-Status-Cause.

Field Descriptions

Field Name	Format	Size	Description
Length	0x00 0x06	2 Byte	Length of message (not including checksum).
Opcode	0xD1	1 Byte	Identifies this opcode type.
Message Source	0x00	1 Byte	Message comes from engine.
Status	0x00	1 Byte	
Cause	Reason code	1 Byte	0x01 = Checksum is incorrect. 0x02 = Host is unable to comply with the requested message (e.g., beep code is out of range). 0x06 = Host does not recognize the command.
Checksum		4 Bytes	Checksum of message.

For example: Engine sends NAK to host. (Checksum incorrect is incorrect)

Length	Opcode	Message Source	Status	Cause	Checksum
0x00 0x06	0xD1	0x04	0x00	0x01	0xFF 0xFF 0xFF 0x28

### 4-2-3 DECODE\_DATA

**Description:** Decode data in SCI packet format.

Packet Format

Length	Opcode	Message Source	Status	Code Type	Decode Data	Checksum
	0xF3	0x00				

Checksum=0x100000000-Length-Opcode-Message Source-Status-Code Type-Decode Data.

Field Descriptions

Field Name	Format	Size	Description
Length		2 Byte	Length of message (not including checksum).
Opcode	0xF3	1 Byte	Identifies this opcode type.
Message Source	0x00	1 Byte	Message comes from engine.
Status	0x00 = First transmit 0x01 = Second transmit	1 Byte	Identifies the transmission status.
Code Type	See Table 4-3	1 Byte	Identifies the scanned data code type.
Decode Data	<data>	Variable	Data is decoded data including prefix and suffix sent in ASCII format.
Checksum		4 Bytes	Checksum of message.

Table 4-3 lists all code types supported by the engine. The associated hexadecimal value for each type of barcode (as required) is entered in the Barcode Type field.

**Table 4-3 List of supported Code Types**

Barcode	Code Type	Barcode	Code Type
Code 39	0x01	Code 11	0x0C
Codabar	0x02	EAN 13	0x0B
Code 128	0x03	EAN 13 with 2 Supps.	0x4B
Discrete 2 of 5	0x04	EAN 13 with 5 Supps.	0x8B
IATA 2 of 5	0x05	MSI	0x0E
Interleaved 2 of 5	0x06	EAN 128	0x0F
Code 93	0x07	UPC E1	0x10
UPC A	0x08	UPC E1 with 2 Supps.	0x50
UPC A with 2 Supps.	0x48	UPC E1 with 5 Supps.	0x90
UPC A with 5 Supps.	0x88	Trioptic Code 39	0x15
UPC E0	0x09	Bookland EAN	0x16
UPC E0 with 2 Supps.	0x49	Coupon Code	0x17 Reserved
UPC E0 with 5 Supps.	0x89	GS1 DataBar Limited (RSS-Limited)	0x31
EAN 8	0x0A	GS1 DataBar (RSS-14)	0x30
EAN 8 with 2 Supps.	0x4A	GS1 DataBar Expanded (RSS-Expanded)	0x32
EAN 8 with 5 Supps.	0x8A	Matrix 2 of 5	0x0D

Barcode	Code Type		Barcode	Code Type
China Post (Chinese 2 of 5)	0x72		Code 32	0x20
UK Plessey	0x13		ISBT128	0x19
PDF417	0x11		Aztec	0x2D
MicroPDF417	0x1A		QR	0x1C
Data Matrix	0x1A		Micro QR	0x2C
Han Xin Code	0xFF Reserved		Maxicode	0x25

For example: Engine sends decoded data to host. (UPC-A, data is 6923450656150)

Length	Opcode	Message Source	Status	Code Type	Decode Data	Checksum
0x00 0x13	0xF3	0x00	0x00	0x08	0x36 0x39 0x32 0x33 0x34 0x35 0x30 0x36 0x35 0x36 0x31 0x35 0x30	0xFF 0xFF 0xFC 0x4B

### Host Requirements

If ACK/NAK handshaking is enabled, the host responds to each of these messages.

### Engine Requirements

Decode data is sent in this format if packeted decode data is selected via parameter. The host responds to this message with a HOST\_ACK, if ACK/NAK handshaking is enabled.

#### 4-2-4 PARAM\_SEND\_ENGINE

Description: Respond to a PARAM\_REQUEST\_HOST.

Packet Format

Length	Opcode	Message source	Status	Beep code	Para. code	Value. length	Para. value	Checksum
	0xD7	0x00	0x00	0xFF				

Field Descriptions

Field Name	Format	Size	Description
Length		2 Byte	Length of message (not including checksum).
Opcode	0xD7	1 Byte	Identifies this opcode type.
Message Source	0x00	1 Byte	Message comes from engine.
Status	0x00	1 Byte	
Beep code	0xFF	1 Byte	If no beep is required, set this field to 0xFF.
Para. code	<Para_Code_HighByte> <Para_Code_LowByte>	2 Bytes	Each parameter code has two byte.
Value. length		Variable	The counter of the Parameter value.
Para. value		Variable	
Checksum		4 Bytes	

Example 1:

Host requests parameter 0x04 0x4D.

Length	Opcode	Message Source	Status	Request Data	Checksum
0x06	0xD7	0x04	0x00	0x04 0x4D	0xFE 0xCE

Engine sends value of parameter 0x04 0x4D.

Length	Opcode	Message source	Status	Beep code	Para. code	Value. length	Para. value	Checksum
0x00 0x0A	0xD7	0x00	0x00	0xFF	0x04 0x4D	0x01	0x01	0xFF 0xFF 0xFD 0xCD

Example 2:

Host requests parameter 0x04 0x4D and parameter 0x04 0xB1.

Length	Opcode	Message Source	Status	Request Data	Request Data	Checksum
0x08	0xD7	0x04	0x00	0x04 0x4D	0x04 0xB1	0xFE 0x17

Engine sends value of parameter 0x04 0x4D and parameter 0x04 0xB1.

Length	Opcode	Message source	Status	Beep code	Para. code	Value. length	Para. value	Para. code	Value. length	Para. value	Checksum
0x00 0x0E	0xD7	0x00	0x00	0xFF	0x04 0x4D	0x01	0x01	0x04 0xB1	0x01	0x01	0xFF 0xFF 0xFD 0x12

## 4-2-5 REPLY\_REVISION

**Description:** Reply to REQUEST\_REVISION command with software revision string.

Packet Format

Length	Opcode	Message Source	Status	Revision	Checksum
	0xA4	0x00	0x00		

Field Descriptions

Field Name	Format	Size	Description
Length		2 Byte	Length of message (not including checksum).
Opcode	0xA4	1 Byte	Identifies this opcode type.
Message Source	0x00	1 Byte	Message comes from engine.
Status	0x00	1 Byte	
Revision	ASCII data	Variable	Software revision in ASCII.
Checksum		4 Bytes	Checksum of message.

For example: If the HW/SW\_REVISION is "ME5800\_APP\_V1.0.3\_Release/S1.3.4.18/A2.5.8.4", the REPLY\_REVISION message will be:

Length	Opcode	Message Source	Status	Revision	Checksum
0x00 0x36	0xA4	0x00	0x00	0x4D 0x45 0x35 0x38 0x30 0x30 0x5F 0x41 0x50 0x50 0x5F 0x56 0x31 0x2E 0x30 0x2E 0x33 0x5F 0x52 0x65 0x6C 0x65 0x61 0x73 0x65 0x 2F 0x53 0x31 0x2E 0x33 0x2E 0x34 0x2E 0x31 0x38 0x2F 0x41 0x32 0x2E 0x35 0x2E 0x38 0x2E 0x34 0x20 0xAB 0x20 0xF3 0xD7	0xFF 0xFF 0xF1 0x33

Note:

The engine sends its Revision field data string to the host in the following format:

HW/SW\_REVISION<space> ENGINE\_ID<space> REVISION\_CHKSUM

Where:

HW/SW\_RIVISION is the version string including hardware and software information.

ENGINE\_ID is always 0xAB.

REVISION\_CHKSUM is a two-byte checksum. It's the 2's complement sum of the Revision contents excluding REVISION\_CHKSUM.



## 5 SCI transactions

### 5-1 ACK/NAK handshaking

If ACK/NAK handshaking is enabled, all packeted messages must have an ACK or NAK response, unless the command description states otherwise. This parameter is enabled by default, and should remain enabled to provide feedback to the host. Raw decode data and WAKEUP command do not use ACK/NAK handshaking since they are not packeted data. Refer to [Decode data packet format](#) of [3-5 Scan mode & some global settings](#).

- ✚ Following is an example of a problem that can occur when ACK/NAK handshaking is disabled:
  - A.1. The host sends a PARAM\_SEND\_HOST message to the engine to change the baud rate from 9600 to 115200.
  - A.2. The engine cannot interpret the message.
  - A.3. The engine does not implement the changes requested by the host.
  - A.4. The host assumes that the parameter changes have occurred and acts accordingly (i.e. applying the new baud rate at 115200).
  - A.5. Communications are lost because the change did not occur on both sides, since the baud rate for engine is 9600 and the baud rate for the host is 115200.
- ✚ However, if the ACK/NAK handshaking is enabled, the following occurs:
  - B.1. The host sends a PARAM\_SEND\_HOST message to the engine to change the baud rate from 9600 to 115200.
  - B.2. The engine cannot interpret the message.
  - B.3. The engine CMD\_NAKs the message.
  - B.4. The host resends the message.
  - B.5. The engine receives the message successfully, responds with ENGINE\_ACK, and implements parameter changes.

## 5-2 Transaction of decode data

The parameter of **Decode Data Packet Format** controls how decode data is sent to the host. When this parameter is set as **Packeted**, the data is sent in a DECODE\_DATA packet. When the parameter is set as **Raw**, the data is transmitted as raw ASCII data. Refer to **Decode data packet format** of [3-5 Scan mode & some global settings](#).

When decode data is transmitted as raw ASCII data, ACK/NAK handshaking does not apply regardless of the state of the ACK/NAK handshaking parameter.

a) **Flow control** = ACK/NAK, **Decode Data Packet Format** = **Packeted**

The engine sends a DECODE\_DATA packet message after a successful decode. The engine waits for a programmable time-out for a HOST\_ACK response. If it does not receive the response, the engine tries to send twice more before issuing a host transmission error.

If the engine receives a HOST\_NAK from the host, it may attempt a retry depending on the cause field of the HOST\_NAK message.

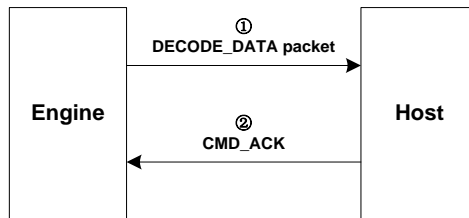

b) **Flow control** = ACK/NAK, **Decode Data Packet Format** = **Raw**

Even though the ACK/NAK handshaking is enabled, no handshaking occurs because the handshaking applies only to packet data.

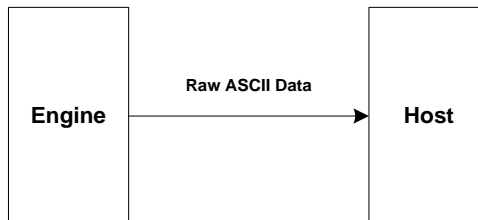

c) **Flow control** = None, **Decode Data Packet Format** = **Packeted**

In this example ACK/NAK does not occur because the ACK/NAK handshaking parameter is disabled.

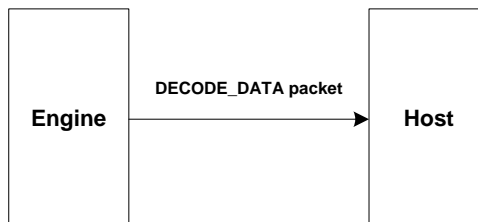

d) **Flow control** = None, **Decode Data Packet Format** = **Raw**

In this example ACK/NAK does not occur because the ACK/NAK handshaking parameter is disabled.

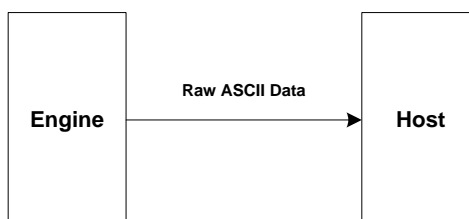

### 5-3 Transaction examples

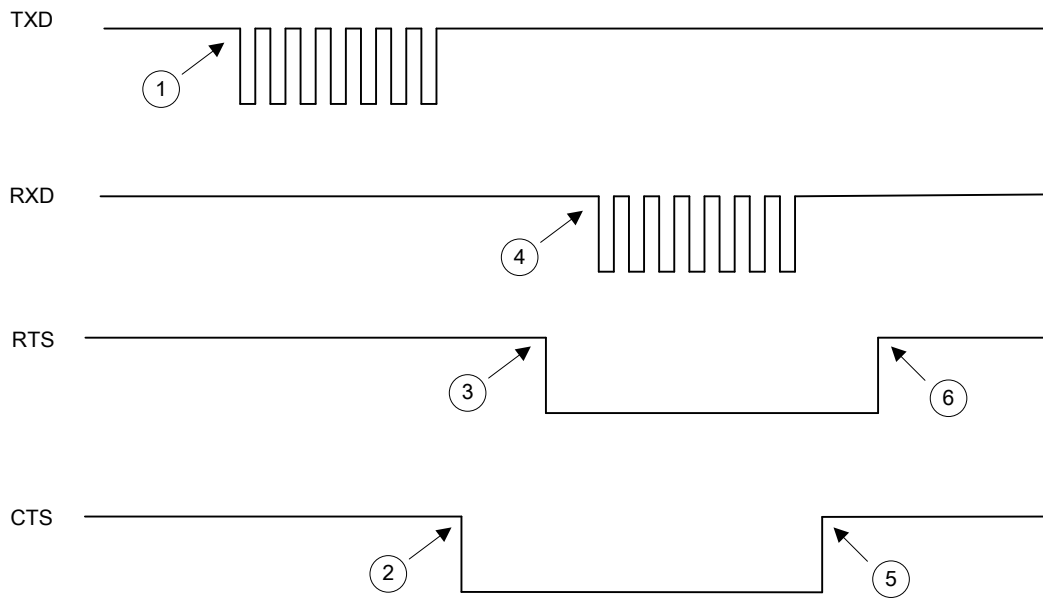

1. Engine transmits packeted decode data.
2. Host requests to send HOST\_ACK.
3. Engine grants permission.
4. Host sends an HOST\_ACK.
5. Host removes request.
6. Engine removes permission.

Figure 5-1 Basic engine initiated transaction

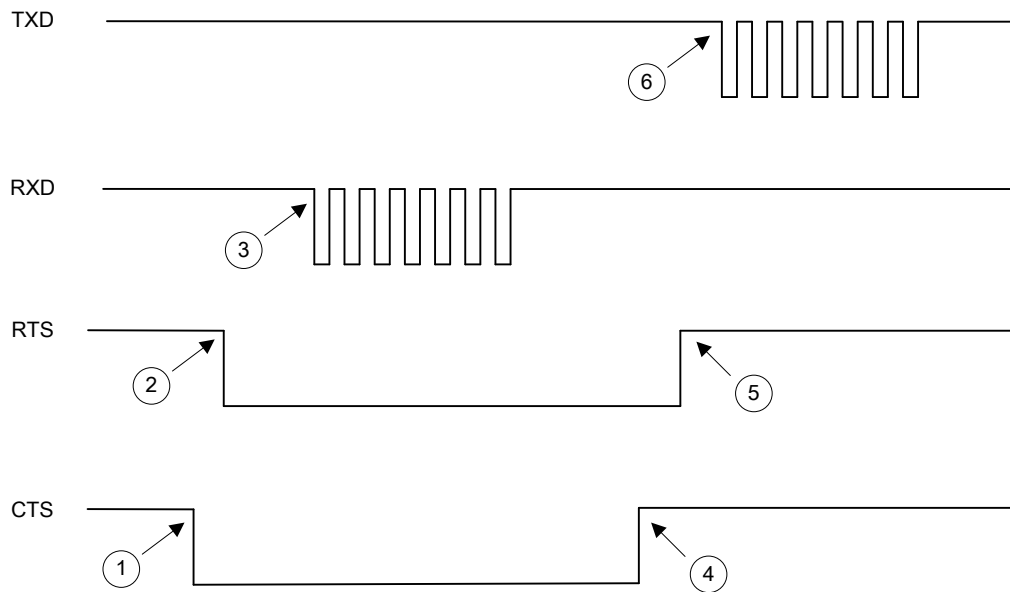

1. Host requests to send BEEP command.
2. Engine grants permission.
3. Host sends a BEEP command.
4. Host removes request.
5. Engine removes permission.
6. Engine sends an ENGINE\_ACK.

**Figure 5-2 Basic host initiated transaction**

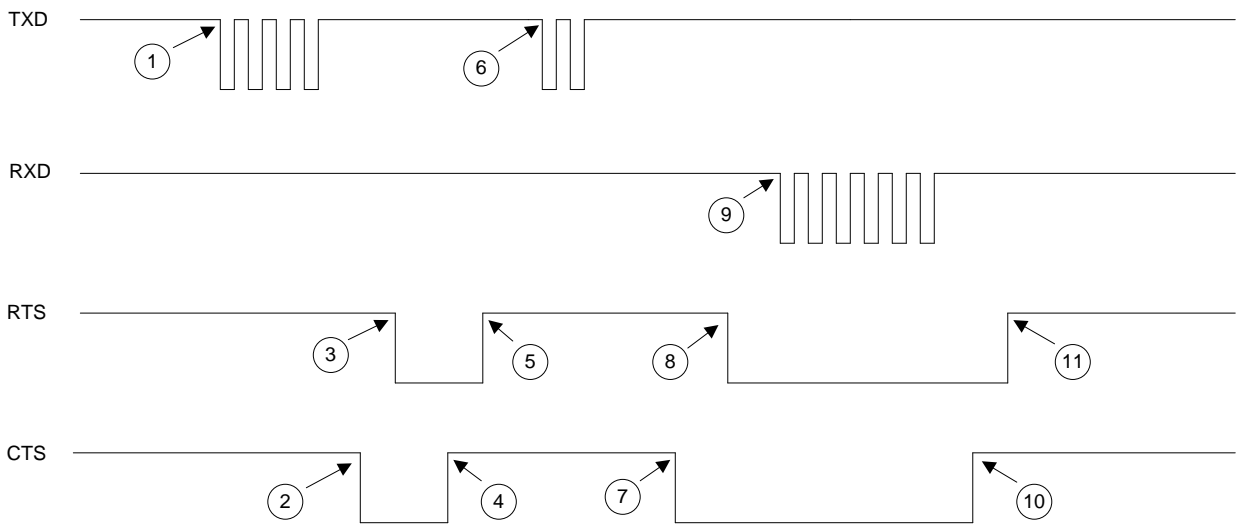

1. Engine starts to transmit packeted decode data.
2. Host asserts RTS causing transmission pause.
3. Engine grants permission for Host to send.
4. Host removes request without sending.
5. Engine removes permission.
6. Engine resumes transmission packeted decode data.
7. Host requests permission.
8. Engine grants permission.
9. Host sends HOST\_ACK.
10. Host removes request when finished sending.
11. Engine removes permission.

**Figure 5-3 Host Interrupts engine's transaction**

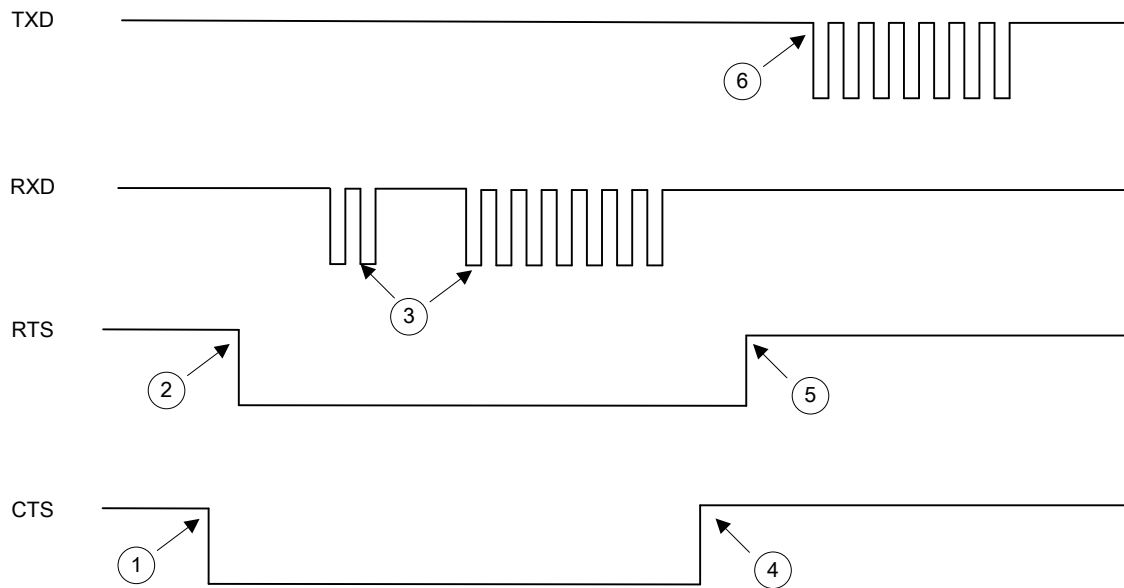

1. Host requests permission to send BEEP command.
2. Engine grants permission.
3. Host sends 3 nulls, then a BEEP command.
4. Host removes request when sending is finished.
5. Engine removes permission.
6. Engine sends an ACK.

**Figure 5-4 Host initiated transmission with leading nulls**

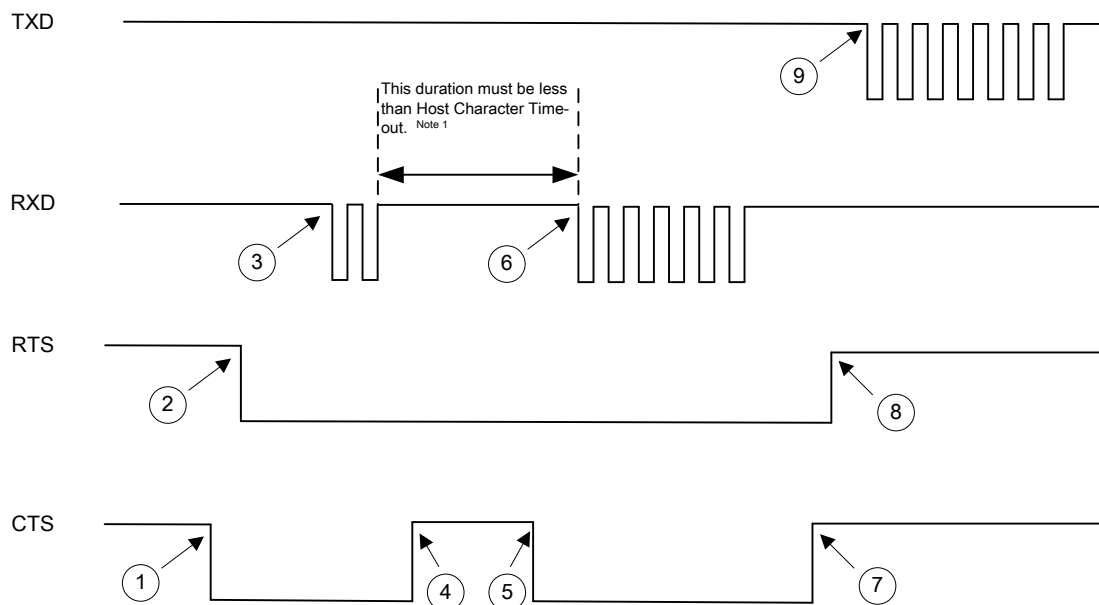

Note 1: The parameter of Host Character Time-out determines the maximum time the engine waits between characters transmitted by the host before discarding the received data and declaring an error. The default value is 200 ms.

1. Host requests permission to send BEEP command.
2. Engine grants permission.
3. Host sends 1/2 BEEP command.
4. Host removes request (ignored by engine until transmission is completed or timed out).
5. Host requests again (ignored by engine until transmission is completed or timed out).
6. Host sends remainder of BEEP command.
7. Host removes request.
8. Engine removes permission.
9. Engine send an ENGINE\_ACK.

Figure 5-5 Host initiated transaction with varying CTS during transmission

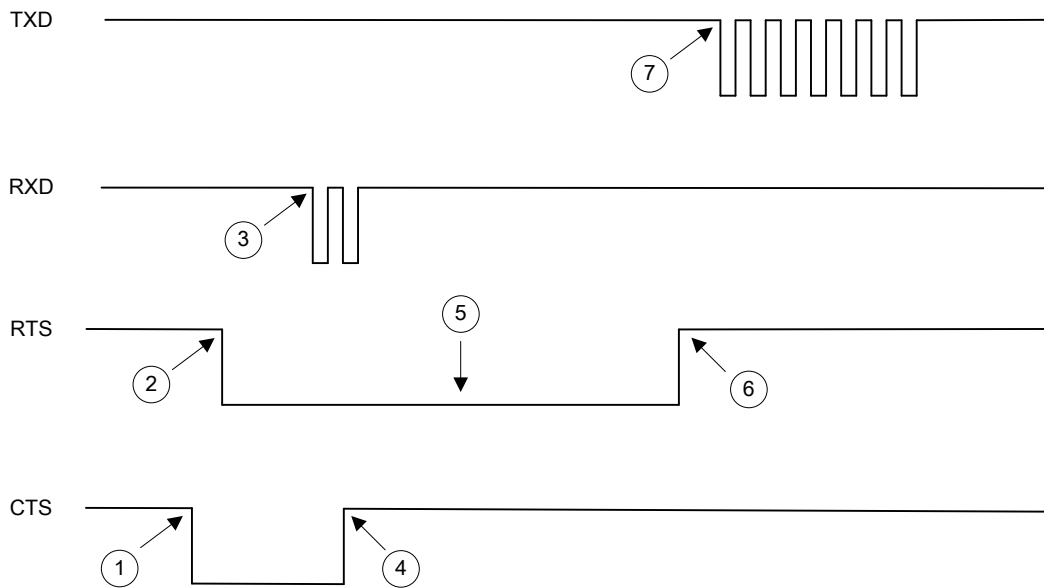

1. Host requests permission to send command.
2. Engine grants permission.
3. Host sends first 2 characters of a command.
4. Host removes request.
5. RTS remains low because engine is still expecting data.
6. Engine times out waiting for a character and removes permission.
7. Engine sends an ENGINE\_NAK to require resending data.

**Figure 5-6 Error transmission: Host sends only the first 2 characters of a 6-character command**



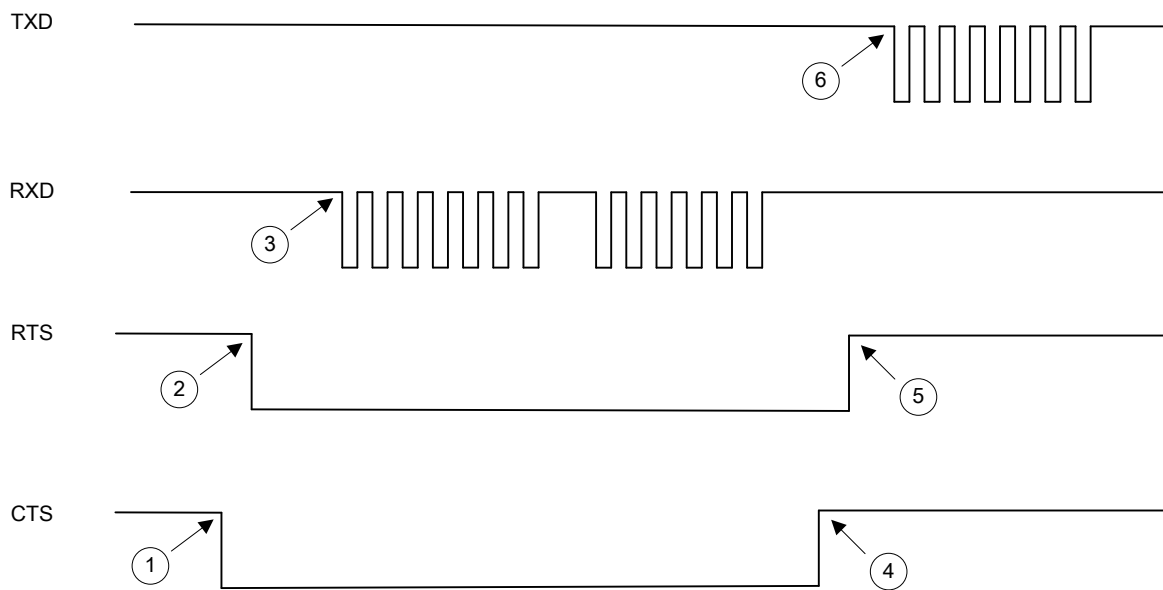

1. Host requests permission to send BEEP command.
2. Engine grants permission.
3. Host sends 2 BEEP commands instead of 1.
4. Host removes request.
5. Engine removes permission.
6. Engine ACKs the first BEEP command.

**Figure 5-7 Error condition: Host sends 2 valid BEEP commands**

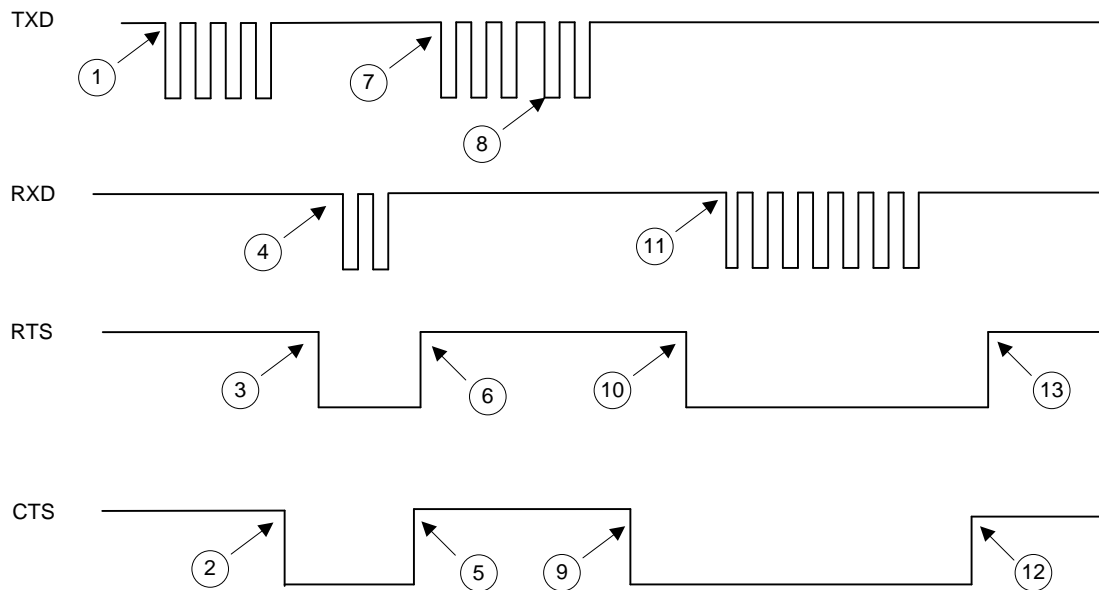

1. Engine starts to transmit packeted decode data.
2. Host requests permission.
3. Engine grants permission.
4. Host causes engine's transmission aborted by sending BEEP command.
5. Host removes request.
6. Engine removes permission.
7. Engine sends an ENGINE\_ACK.
8. Engine resends data.
9. Host requests permission.
10. Engine grants permission.
11. Host sends a HOST\_ACK.
12. Host removes request.
13. Engine removes permission.

**Figure 5-8 Host causes engine to abort transmission**

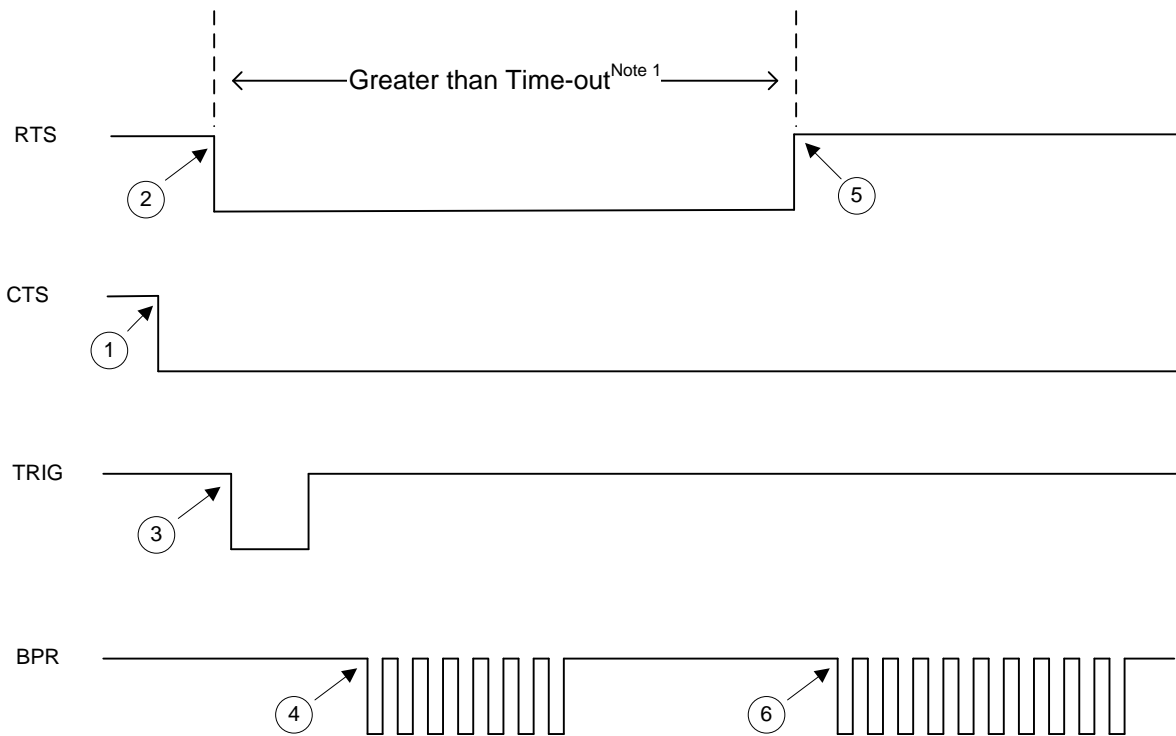

Note 1: The value of Time-out is equal to 3 times of the value of the parameter Host Serial Response Time-out (default value = 2 seconds). Thus the value of Time-out is 6 seconds.

1. Host pulls down the CTS to wake up the engine.
2. Engine grants permission.
3. Host pulls down the Trigger to start decode.
4. Beep after succeeding in decoding the barcode.
5. Time out, engine removes request.
6. Beep after failed to transmit decode data.

**Figure 5-9 Host prohibits engine to transmit**

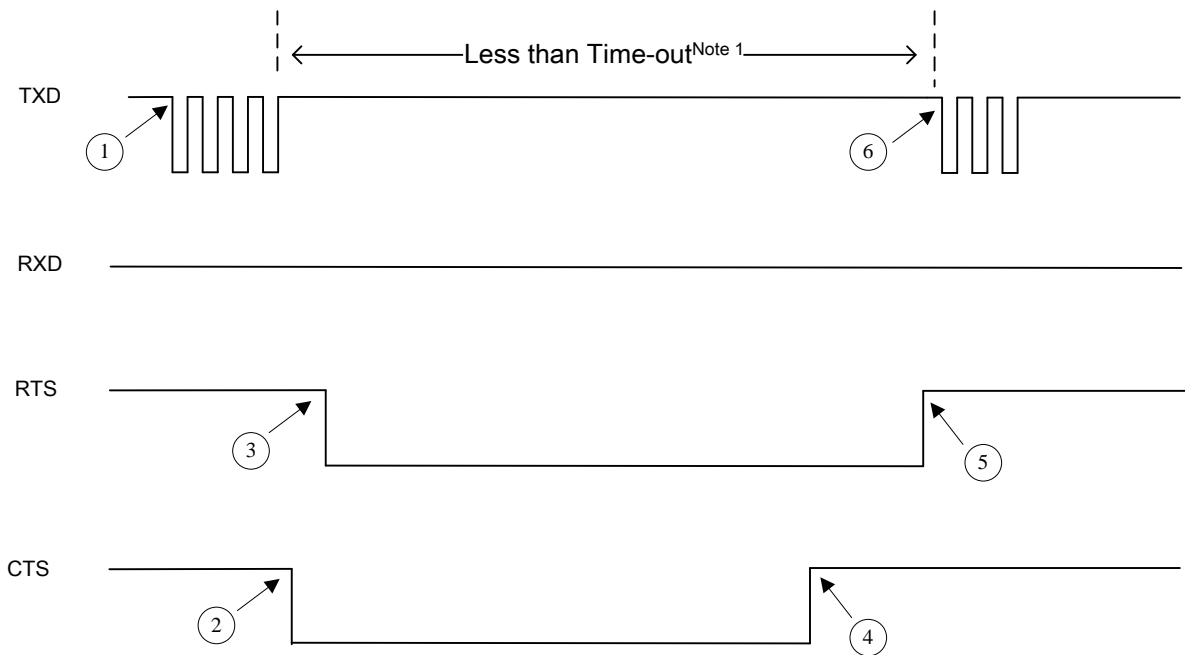

Note 1: The value of Time-out is equal to the value of the parameter Host Serial Response Time-out (default value = 2 seconds). Thus the value of Time-out is 2 seconds.

1. Engine starts to transmit packeted decode data.
2. Host asserts RTS causing transmission pause.
3. Engine grants permission for host to send.
4. Host removes request without sending.
5. Engine removes permission.
6. Engine resumes transmission.

**Figure 5-10 Host pauses engine to transmit**

## 5-4 SCI transaction notes

### a) RTS/CTS Lines

It is recommended that all transactions use RTS/CTS handshaking.

### b) ACK/NAK Option

ACK/NAK handshaking can be enabled or disabled. This handshaking is disabled by default; disabling this is not recommended as it can lead to communication problems, since handshaking is the only indication that a message was received and if it was received correctly. ACK/NAK is not used with unpacked decode data regardless of whether or not this option is enabled.

### c) Number of Data Bits

All communication with the engine must use eight bit data.

### d) Host Serial Response Time-out

The Host Serial Response Time-out parameter determines how long to wait for a handshaking response before trying again, or aborting any further attempts. Both the host and engine should apply the same parameter value during communication.

A temporary change may be made to the Host Serial Response Time-out when the host takes longer to process an ACK, or longer data string. Frequent permanent changes are not recommended due to the limited write-cycles of flash memory.

### e) Retries

When sending data, the host should resend twice after the initial send if the engine does not respond with an ACK or NAK (if ACK/NAK handshaking is enabled), or response data (e.g., PARAM\_SEND, REPLY\_REVISION). If the engine replies with an ENGINE\_NAK message, the host resends the data. All resent messages must set Status byte to Resend.

The engine resends data two times after the initial send if the host fails to reply with an ACK or NAK (if ACK/NAK handshaking is enabled).

### f) Baud Rate, Stop Bits, Parity, Response Time-out, ACK/NAK Handshake

If the serial parameters above are changed using PARAM\_SEND, the ACK response to the PARAM\_SEND uses the previous values for these parameters. The new values then take effect for the subsequent transaction.

### g) Errors

The engine generates a communication error when:

1. The CTS line is asserted when the engine tries to transmit, and is still asserted on each of 2 successive retries.
2. Or failed to receive an ACK or NAK after initial transmit and two resends.

### h) SCI Communication Notes

If hardware handshaking is not used, messages should be spaced sufficiently apart, and the host must not communicate with the engine when the engine is sending.

If hardware handshaking is used, frame each message properly with the handshaking signals. Do not try to send two commands within the same handshaking frame.

There is a permanent/temporary bit in the PARAM\_SEND message. Temporary changes are lost when

power is removed from the engine. Permanent changes are written to flash memory. Frequent permanent changes are not recommended due to the limited write-cycles of flash memory. Do not scan configuration barcodes and send parameters via SCI simultaneously. All parameters can be accessed via SCI, so configuration barcode scanning is not necessary.

## 6 Enable & Disable “NR”



**%NRON%**

### Enable “NR”

If it is enabled, while the engine receives the STOP\_DECODE command or fails to decode a barcode within the Scan standby duration time, the engine will transmit “NR”.



**%NROFF**

### Disable “NR” (Default)

## 7 Enable & Disable configuration by scanning barcode

Note: The setting of the below two barcodes does affect the operation of scanning the barcodes in 12 Return default parameters & firmware version.



### Enable configuration by scanning barcode

The default status of the engine is enabled to scan configuration barcode.



### Disable configuration by scanning barcode

Scan the above barcode to disable scanning configuration barcode except Enable configuration by scanning barcode and Disable configuration by scanning barcode. Then the engine will not operate configuration by scanning configuration barcodes, and the data string of configuration barcode will be displayed.



## 8 Glossary

<b>Bar</b>	The dark element in a printed barcode.
<b>Space</b>	The lighter element of a barcode formed by the background between bars.
<b>Barcode density</b>	The thickness of the narrowest element in the barcode (e.g. 5 mil, 10 mil, etc).
<b>Resolution</b>	The narrowest element dimension which can be distinguished by a particular reading device or printed with a particular device or method.
<b>Decode zone</b>	An area within an engine's field of view.
<b>MIL</b>	1 mil = 1 thousandth of an inch, i.e. 0.0254 mm.
<b>Byte</b>	1 byte = 8 bits
<b>Bit</b>	1 byte = 8 bits

## 9 ASCII table

H L		for keyboard wedge		for TTL-232	
		0	1	0	1
0		Null		NUL	DLE
1		Up	F1	SOH	DC1
2		Down	F2	STX	DC2
3		Left	F3	ETX	DC3
4		Right	F4	EOT	DC4
5		PgUp	F5	ENQ	NAK
6		PgDn	F6	ACK	SYN
7			F7	BEL	ETB
8		Bs	F8	BS	CAN
9		Tab	F9	HT	EM
A			F10	LF	SUB
B		Home	Esc	VT	ESC
C		End	F11	FF	FS
D		Enter	F12	CR	GS
E		Insert	Ctrl+	SO	RS
F		Delete	Alt+	SI	US

Notes: The 2nd and the 3rd columns above are used for keyboard wedge only.

H L	2	3	4	5	6	7
0	SP	0	@	P	`	p
1	!	1	A	Q	a	q
2	"	2	B	R	b	r
3	#	3	C	S	c	s
4	\$	4	D	T	d	t
5	%	5	E	U	e	u
6	&	6	F	V	f	v
7	'	7	G	W	g	w
8	(	8	H	X	h	x
9	)	9	I	Y	i	y
A	*	:	J	Z	j	z
B	+	;	K	[	k	{
C	,	<	L	\	l	
D	-	=	M	]	m	}
E	.	>	N	^	n	~
F	/	?	O	_	o	DEL

Example: ASCII "A" = "41".

## 10 Barcode representing non-printable character

Notes to make the following barcode:

- 1 According to different barcode printing software, the method of printing following barcode is different.
- 2 If using CODESOFT software, firstly read the information through “Help→Index→Code128→Special input syntax”. Also refer to ASCII table. For example, if we wish to make “F1” barcode, select “Code128”, then select “CODE A” type, and input “{DC1}” as data.



Up ↑



Down ↓



Left ←



Right →



Page Up



Page Down



Backspace



Tab



Home



End



Enter



Insert



Delete



F1



F2



F3



F4



F5



F6



F7



F8



F9



F10



Esc



F11



F12

# 11 Test barcode symbols

UPC-A  
  
6 59871 23231 9

UPC-E  
  
0 232310 7

UPC-E1  
(Default setting: Read disable)  
  
1 6 5 4 3 2 1 1

EAN-13  
  
1 234567 891019

ISBN/ISSN  
  
9 780194 315104

EAN-8  
  
0123 4510

Code 39  
  
\*0189-+ \$AZ\*

Interleaved 2 of 5  
  
0123456789

Industrial 2 of 5  
(Default setting: Read disable)  
  
0123456789

Matrix 2 of 5  
  
9876543210

Codabar  
  
a01+-.:/\$89a

Code 128



01AZ[+\*/]za98

UCC/EAN 128



01AZ[]+-az54

ISBT 128



=1234 56789

Code 93



01AZ+/\*az89

Code 11

(Default setting: Read disable)



123456789-0

MSI/Plessey

(Default setting: Read disable)



0123456789

UK/Plessey

(Default setting: Read disable)



01ABEF89

China Post



01234567890

GS1 Databar ( GS1 Databar Truncated )



(01) 12345678901231

GS1 Databar Limited



(01) 1 2345678 90126 2

GS1 Databar Expanded



Ab\_09+yZ

PDF417



12=890ab-+%xyz

QR code



1234567890ABCD-+()\*%#^@!XYZ

Micro QR Code

(Default setting: Read disable)



0123456789MicroQR

Data Matrix



123890abc-+&\*%^!mndo

Aztec Code

(Default setting: Read disable)



12345678901234567890

Han Xin Code

(Default setting: Read disable)



1234567890Hanxin

## 12 Return default parameters & firmware version



%%%DEF

### Restore Factory Defaults

If you wish to restore the engine to all the factory default settings, scan the barcode above.



%%WCDF

### Write to Customer Defaults

Write current parameter settings to the customer default settings.



%%RSDF

### Restore Customer Defaults

Restore the customer default settings to current settings.



%%%VER

### Firmware Version list

If you wish to display the firmware version, scan the barcode above.

### 13 Configuration alphanumeric entry barcode



To finish parameter setting, please scan the bar code below.

